

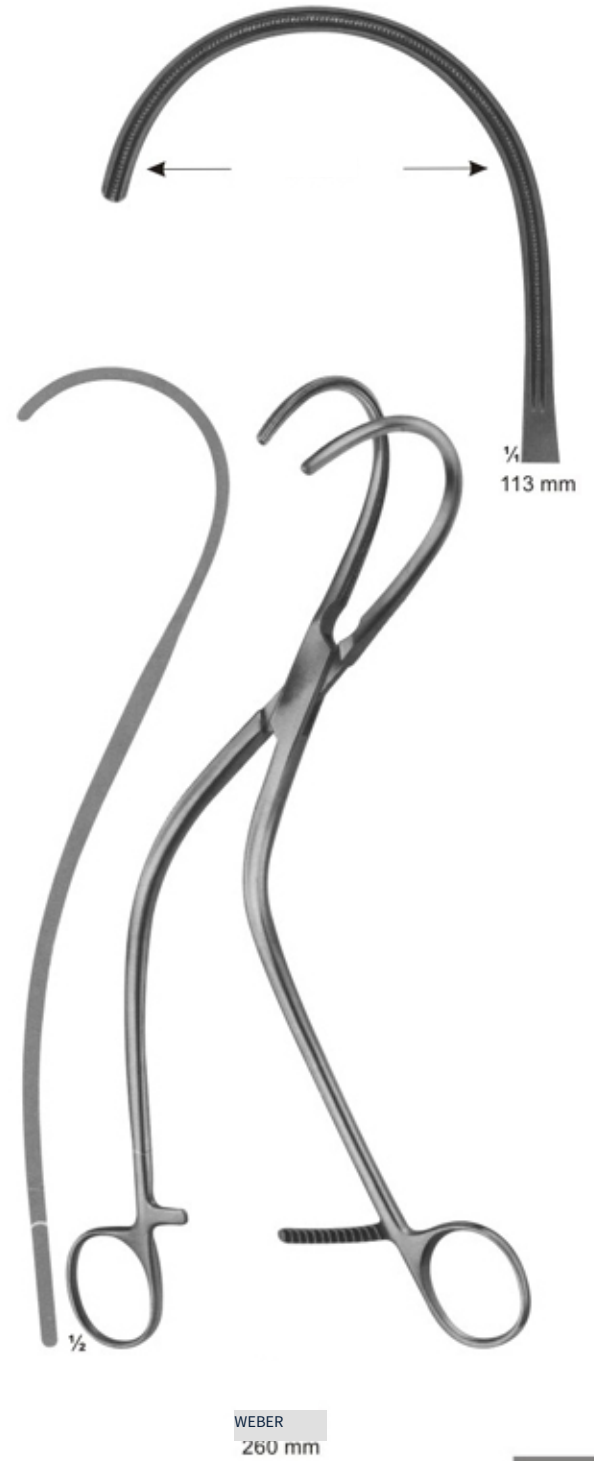

my Anastomosis Clamps





1/2 **14-146 - 149**
De Parker

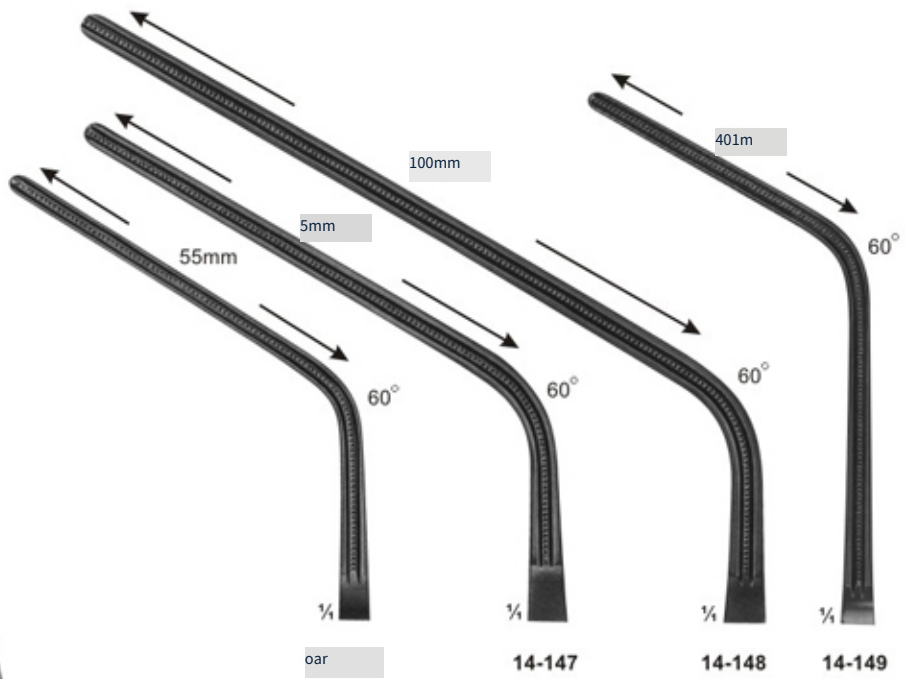

Total Long	230mm	280 mm	2305 mm	240mm
全長 ofjaws	851mm	100mm		931mm



1/2 **14-150 - 153**
De Baker

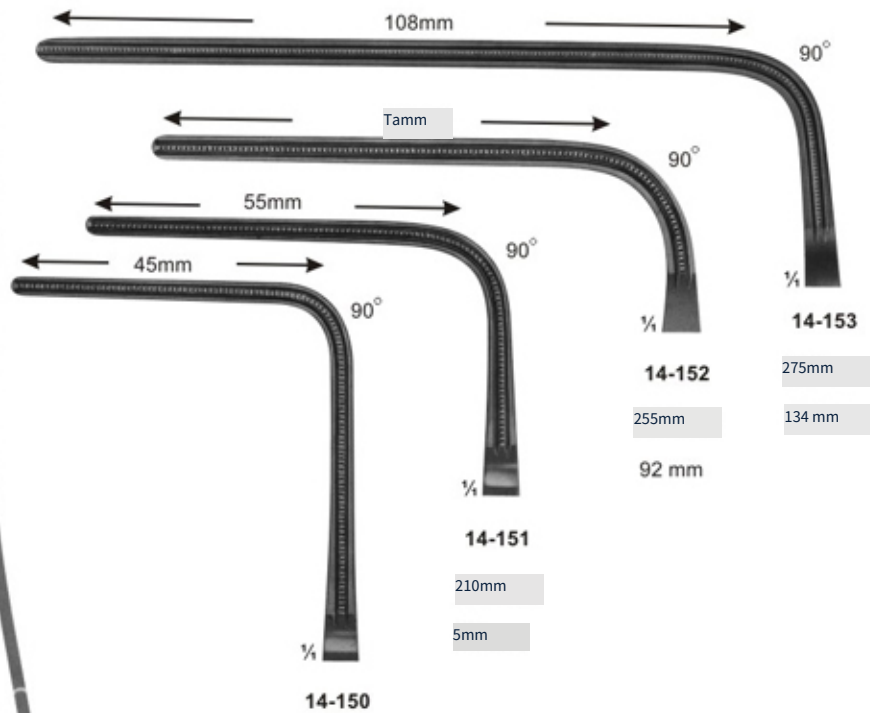

Total Long	225 mm			
全長 ofjaws	93 mm			



14-154
SCHUMACHER
Sternum shears
240mm



14-155
LEBSCHÉ
Sternum cise!
200 mm



14-156
230mm



14-157
COLLIN
195 mm



14-158
GLUCK
190 mm



14-159
BETHUNE
340 mm



14-160
BRUNNER
Universal pattern
340 mm



14-161
GIERTZ-STILLÉ
250 mm

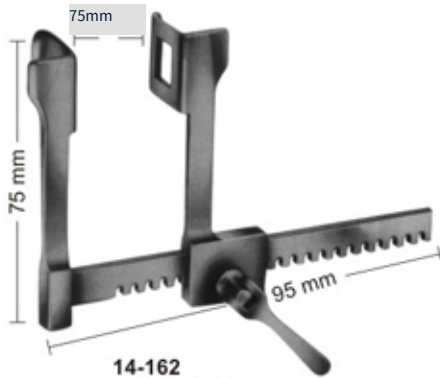

**14-162
FINOCHIETTO
Blades**
5021 mm

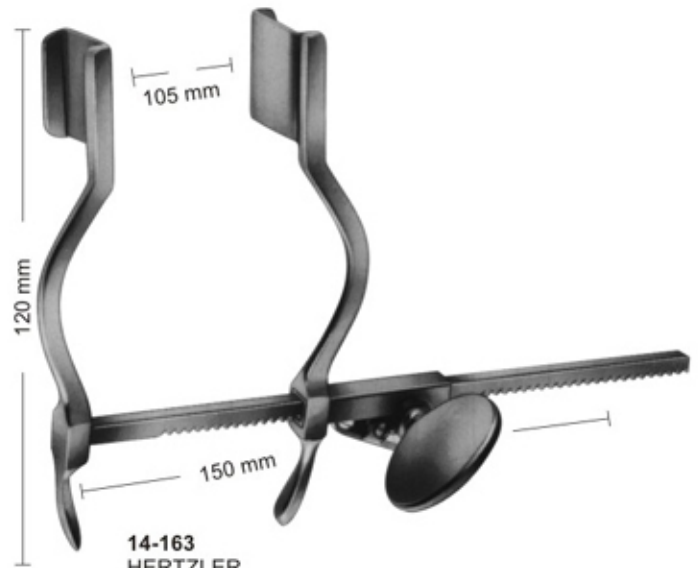

**14-163
HERTZLER
Blades**
20x25 mm

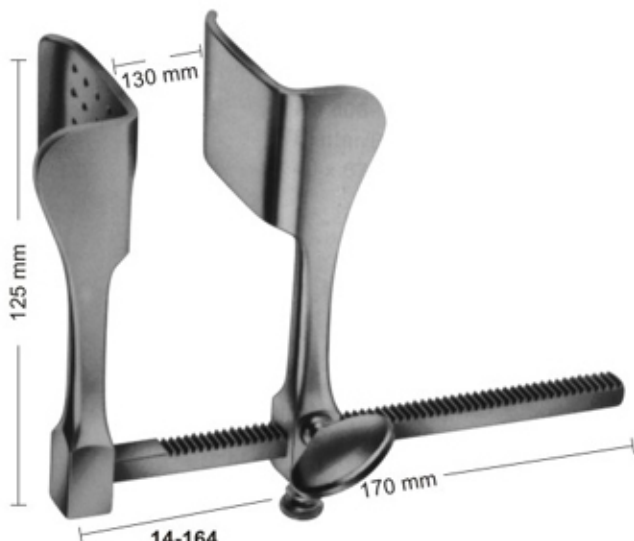

**14-164
TUFFIER
Blades**
43X53 mm

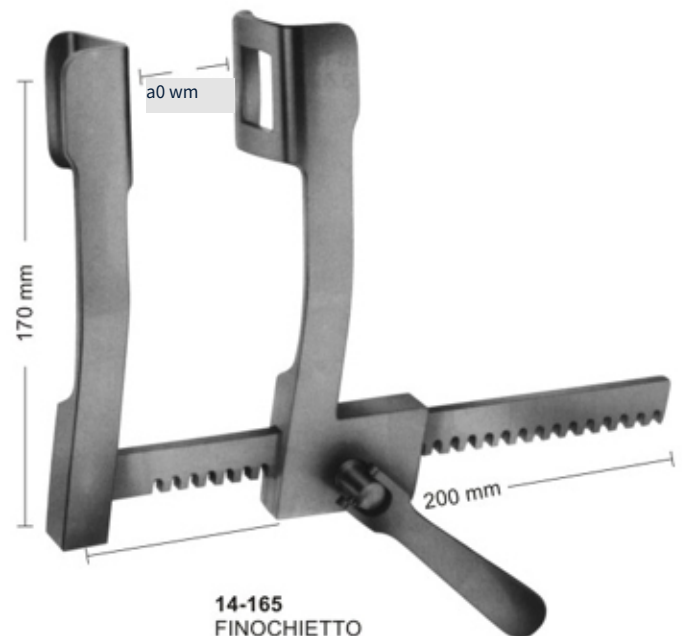

**14-165
FINOCHIETTO
Blades**
36x45 mm



14-166
Sei _LORS
Rib spreader
with swivel |
200 mm



14-167
BAILEY
150 mm



14-168
for children

14-169
for adults

14-168 - 169

15-101
1 mm

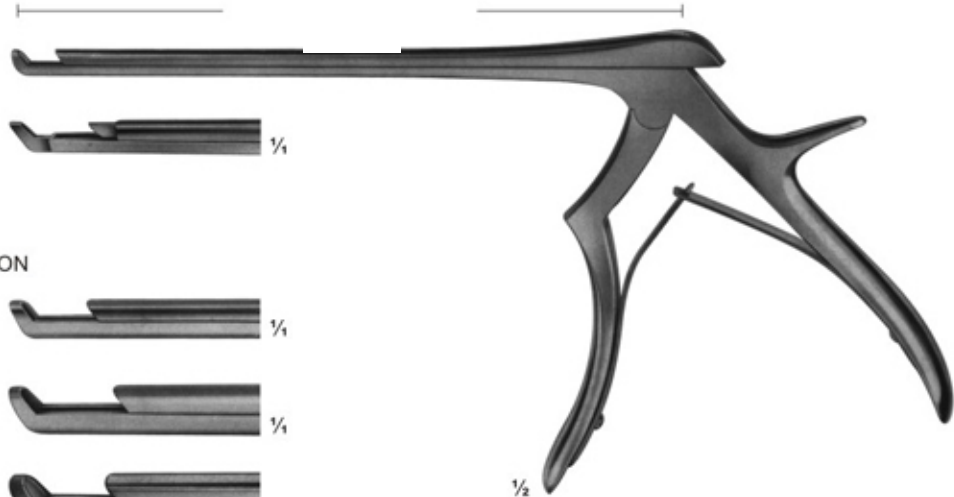

FERRIS-SMITH-KERRISON

15-102
2mm



1/4

15-103
3mm



1/4

15-104
4mm



1/4

15-105
5 mm



1/4

15-101 - 105

90° upwards cutting

15-106
1 mm

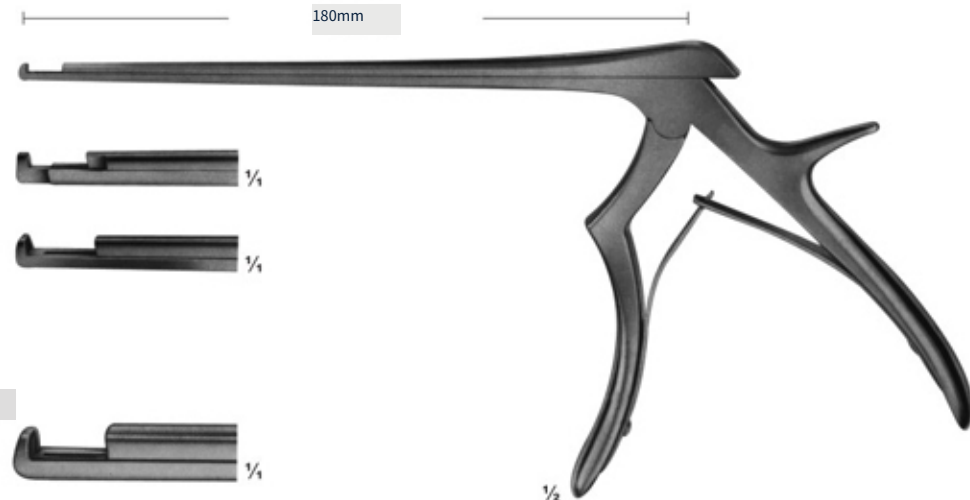

180mm

1/4

15-107
2mm



1/4

FERRIS-SMITH-KERRISON

15-108
Sem



1/4

15-109
4 mm



1/4

15-110
5 mm



1/4

15-106 - 110



15-111 - 15-112
KERRISON

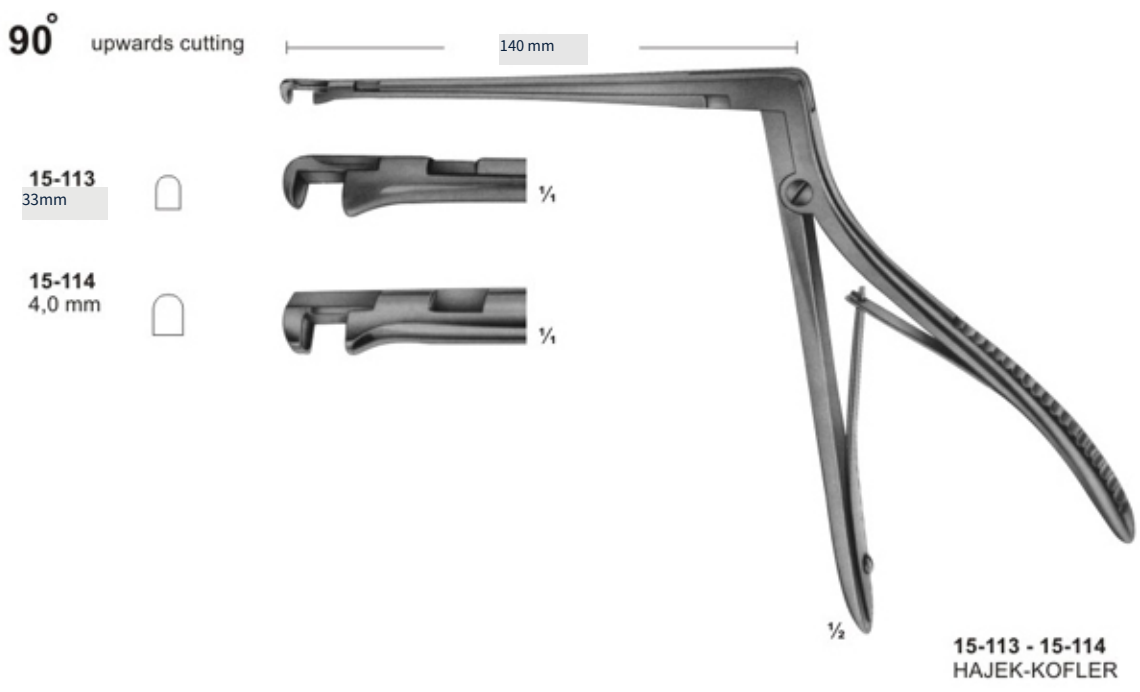

15-113 - 15-114
HAJEK-KOFLER

LOVE-GRUENWALD

15-115
2 X 10 mm

15-116
3 X 10 mm

SPURLING
15-117
4 X 10 mm

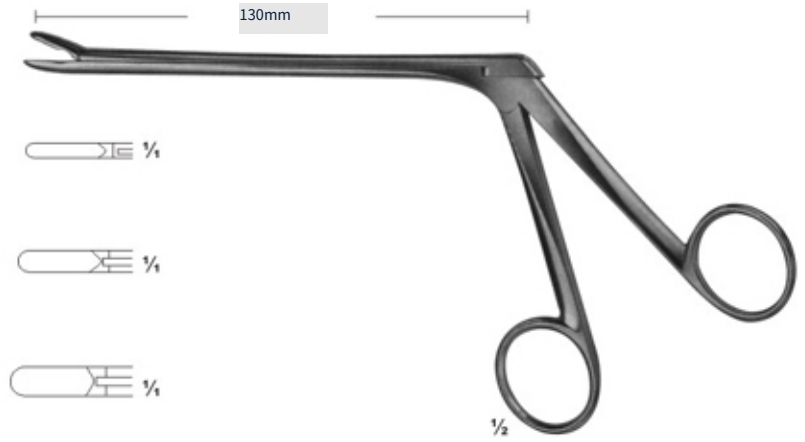

15-115 - 15-117

15-118
2 mm

15-119
3mm

15-120
4mm

15-121
5 mm

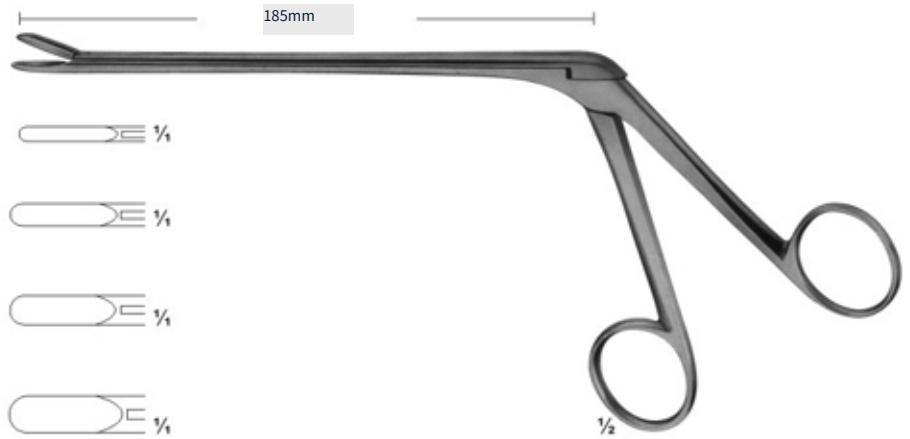

15-118 - 15-121
CASPAR

150°

15-122
2 mm

15-123
3mm

15-124
4 mm

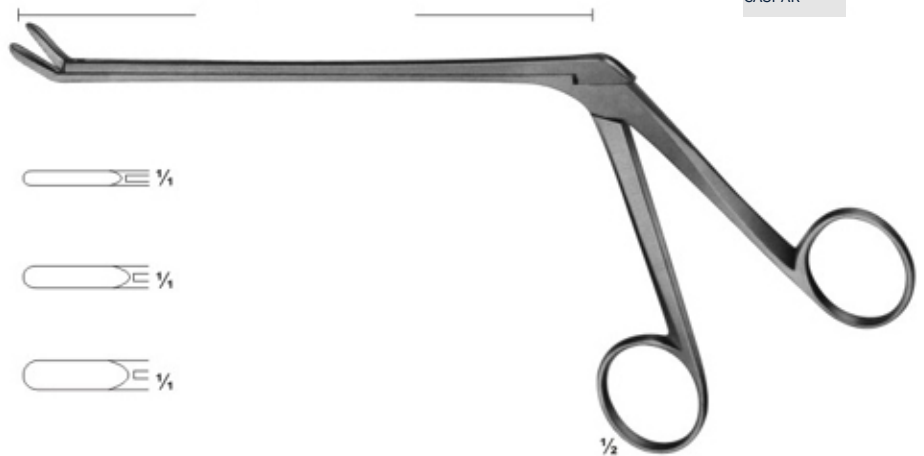

15-122 - 15-124
CASPAR

Angled postions 用 rongours

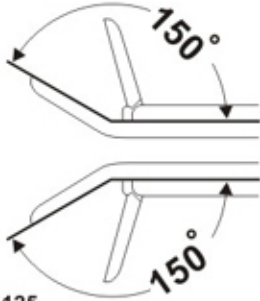

15-125
30mm

15-126
36mm

15-127
42mm

15-128
4,8 mm

15-129
5,8 mm

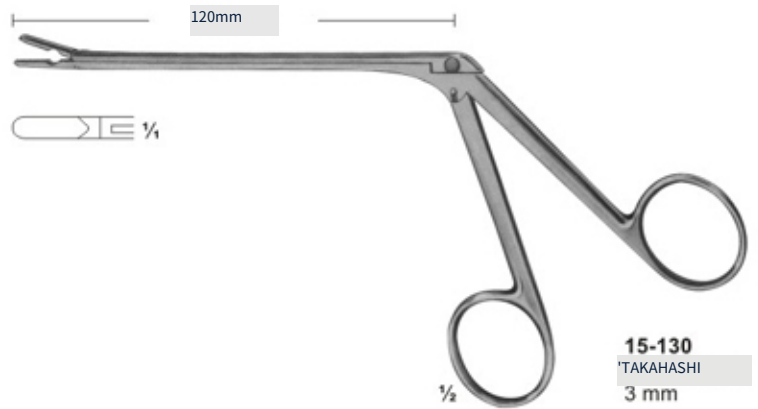
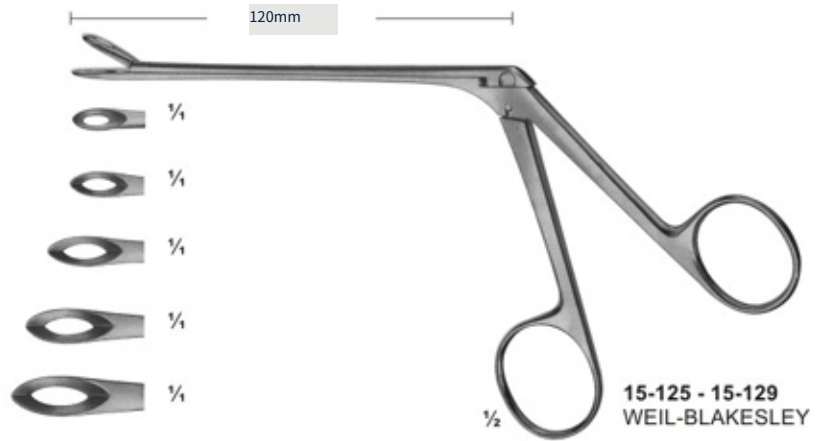
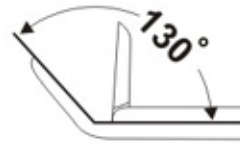
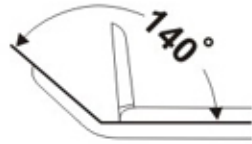

130°

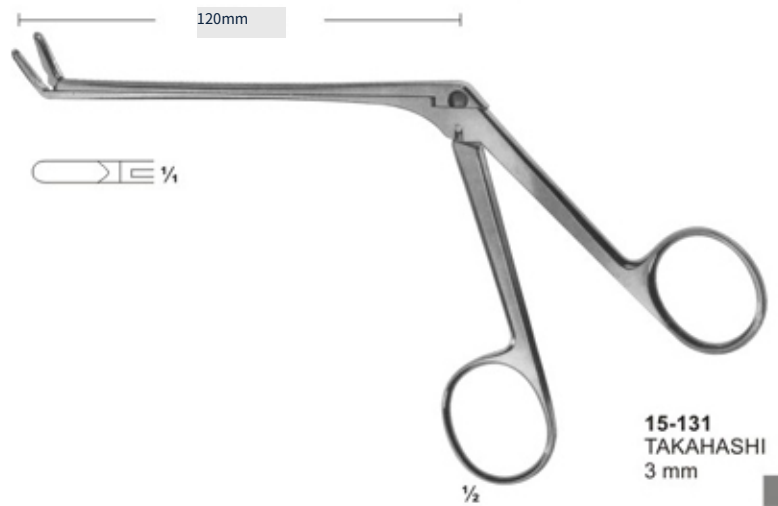

150°

下顎 part movable

15-132
2 mm

15-133
3 mm

15-134
4mm

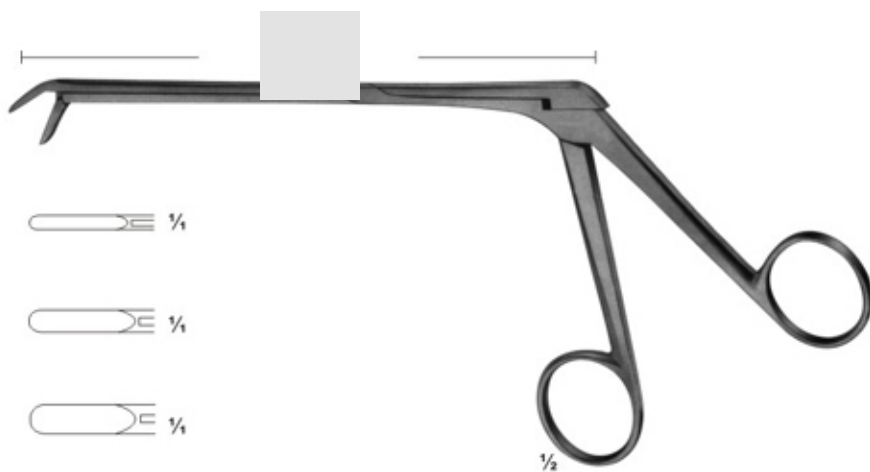

15-132-15-194
CASPAR

全長の shat
140 mm

全長の shat
160 mm

15-135

15-140

15-145

2x12mm

1/4

15-136

15-141

15-146

3 X12 mm

1/4

15-137

15-142

15-147

4x04 mm

1/4

15-138

15-143

15-148

5x14 mm

1/4

15-139

core

15-149

6x16mm

1/4



15-135 - 15-149
CASPAR

150°

全長の shat
140 mm

全長の shat
60mm

全長の shat
180 mm

size of jaws

15-150

15-153

15-156

3x12mm

1/4

15-151

15-154

15-157

4x04 mm

1/4

15-152

15-155

15-158

5 X14 mm

1/4

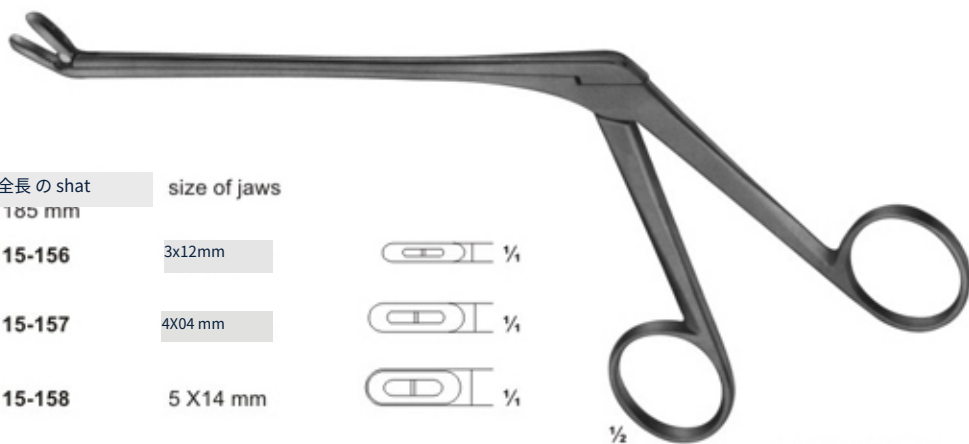

15-150 - 15-158
CASPAR

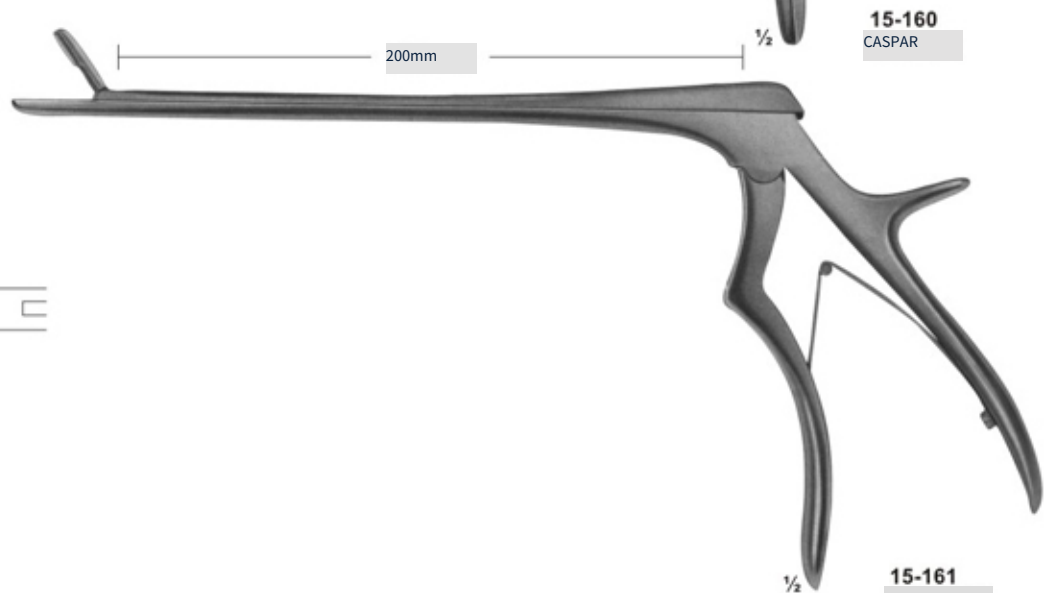
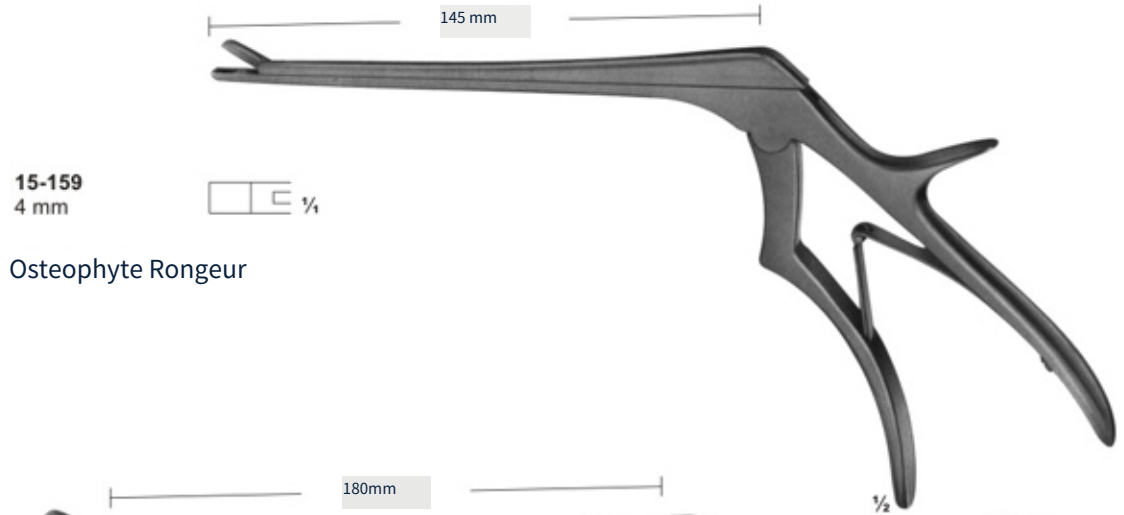

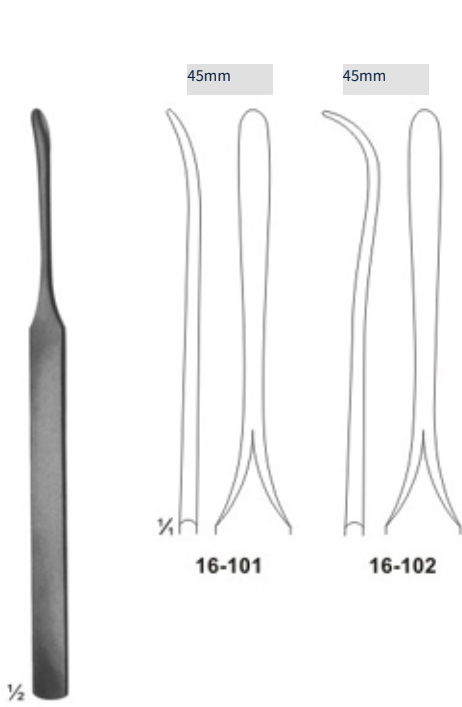

16-101 - 102
KONIG
587mm



16-103
WILLIGER

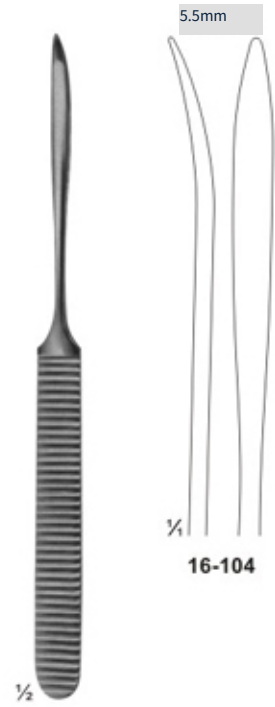

16-104
WILLIGER
Yromm

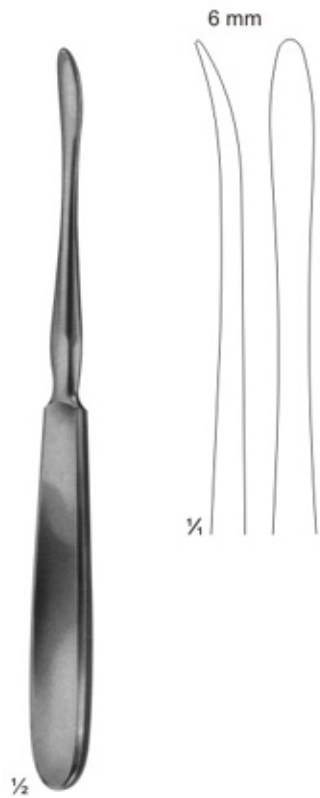

16-105
QUERVAIN
195 0m

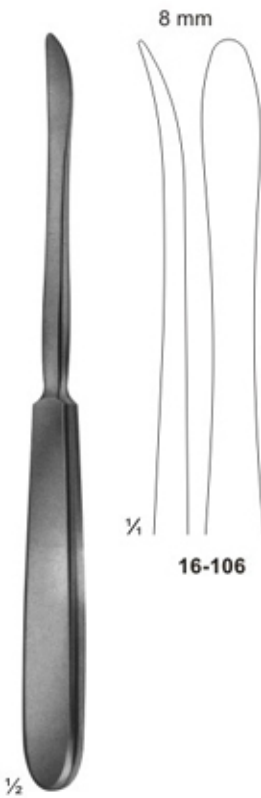

16-106 - 107
LANGENBACK
195 mm



16-107

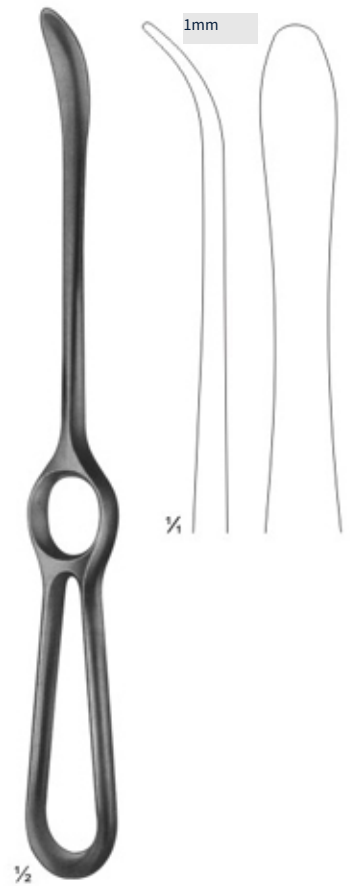

16-108
LANGENBACK
250mm



16-109
LANE TRETHOWAN
215mm



16-110
LANE
255m



16-111
LANGE-HOHMANN
250mm



16-113 280mm

16-112
30mm

16-113
3mm



32mm 461mm

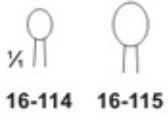

16-114 16-115



1/2

16-114
PARTSCH
150 mm

4 mm



1/4



1/2

16-116
PARTSCH mod. LANGE
145m

44mm



1/4



1/2

16-117
MC KENTY
155 mm

5 mm



1/4

ial



1/2

16-118
KOENIG
15mm

8mm



1/4



1/2

16-119
TRELAT
150m

42mm



1/4



1/2

16-120
WILLIGER
140 mm

6 mm



1/4



1/2

16-121
R

4mm



1/4



1/2

16-122
Josten
170 mm

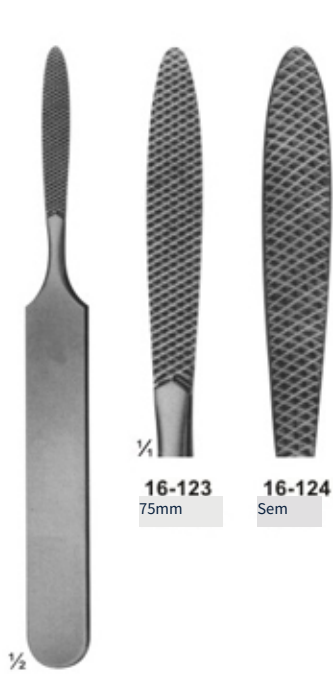

$\frac{1}{2}$
16-123
JOSEPH
fine, chequered

$\frac{1}{4}$
16-123
75mm

$\frac{1}{4}$
16-124
Sem

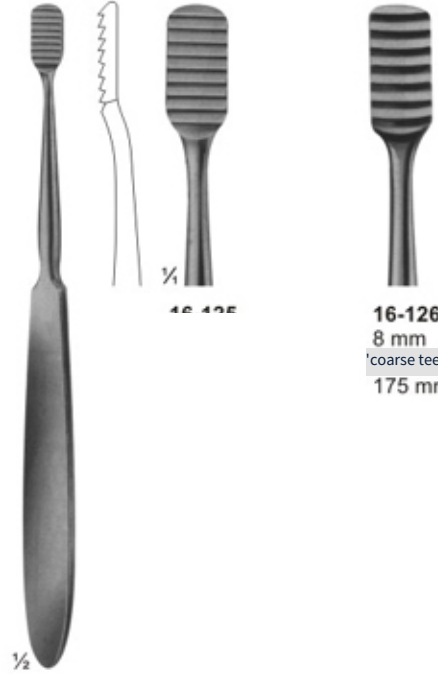

$\frac{1}{2}$
16-125 - 16-126
LEWIS

$\frac{1}{4}$
16-126
8 mm
coarse teeth
175 mm



$\frac{1}{2}$
16-127
MALTZ
own stroke
80mm

$\frac{1}{4}$
9 mm



$\frac{1}{2}$
16-128 - 16-129
AUF右
Op stroke
cary
down stroke
220 mm

$\frac{1}{4}$
16-128
Simm

$\frac{1}{4}$
16-129
9 mm



$\frac{1}{2}$
16-130
GALLAHER
190mm

$\frac{1}{4}$
65mm



16-131
JACOBSON
140 mm

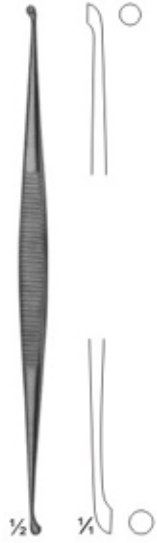

16-132
MARTINI
140 mm



16-133
MARTINI
140 mm



16-134
WILLIGER
145 mm



16-135
JANSEN



16-136
BARTH
180 mm

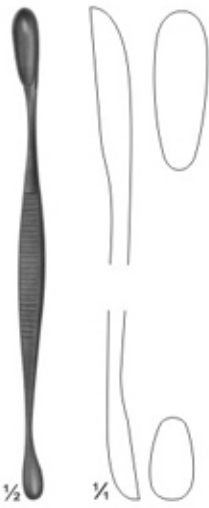

16-137
VOLKMANN
130 mm

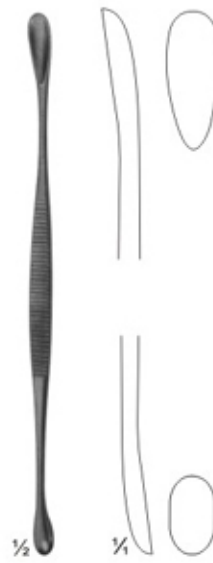

16-138
VOLKMANN
145 mm

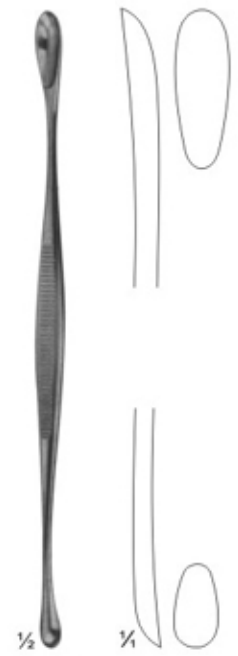

16-139
VOLKMANN
170 mm

den Kopf des jeweiligen Hammers



20 mm

1/2

17-101

MEAD

185 g

with interchangeable

Plastic asks

pair of spare disks



225mm

1/2

17-103

140 g

with interchangeable

Paste asks

pair of spare disks



930mm

1/2

17-105

core

140 g

Flat



322 mm

1/2

17-106

165 g

lead with hood

190mm

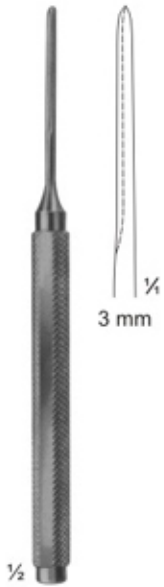

17-107
 MANNERFELT
 Gouge
 155 mm

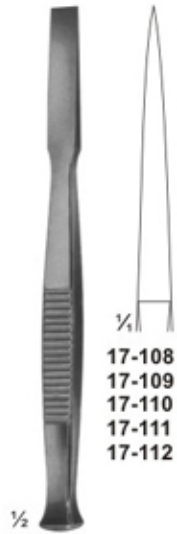

17-108 - 112
 Osteotomes
 140 mm

- 17-108** 4mm
- 17-109** 6 mm
- 17-110** 8mm
- 17-111** 10mm
- 17-112** 12 mm

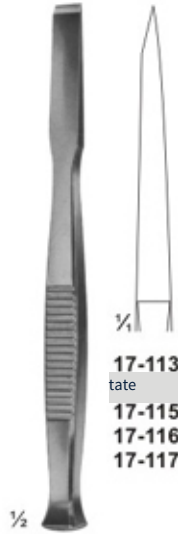

17-113 - 117
 Chisels
 140 mm

- 17-113** 4 mm
- 17-114** 6 mm
- 17-115** 8 mm
- 17-116** 10mm
- 17-117** 12mm

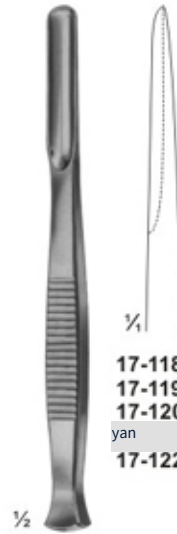

17-118 - 122
 Gouges
 140 mm

- 17-118** 4 mm
- 17-119** 6 mm
- 17-120** 8 mm
- 17-121** 10mm
- 17-122** 2mm

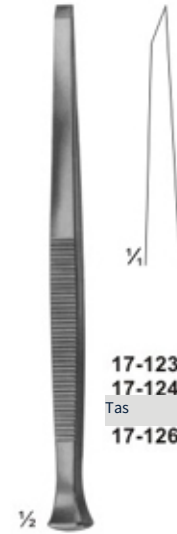

PARTSCH
17-123 - 126
 Chisels
 140 mm

- 17-123** 3mm
- 17-124** 4 mm
- 17-125** 5 mm
- 17-126** 6 mm

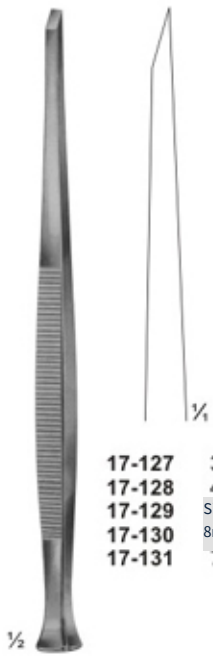

PARTSCH
17-127 - 131
 Chisels
 170 mm

- 17-127** 3 mm
- 17-128** 4 mm
- 17-129** 5mm
- 17-130** 8mm
- 17-131** 7 mm

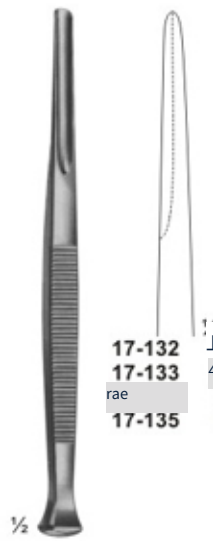

PARTSCH
17-132 - 135
 Gouges
 140 mm

- 17-132** 3 mm
- 17-133** 4mm
- 17-134** 5 mm
- 17-135** 6 mm



PARTSCH
17-136 - 140
 Gouges
 170 mm

- 17-136** 3mm
- 17-137** 4 mm
- 17-138** 5mm
- 17-139** 8mm
- 17-140** 7 mm

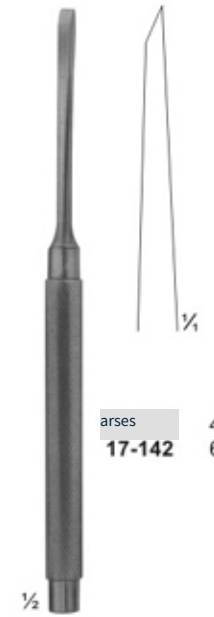

Lucas
17-141 - 142
 Chisels
 160 mm

- 17-141** 4 mm
- 17-142** 6 mm

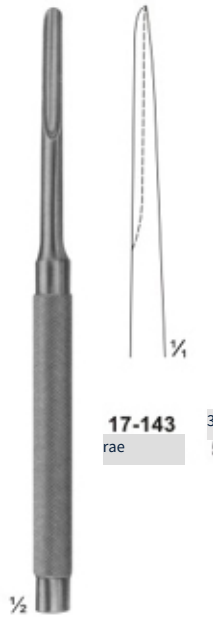

Lucas
17-143 - 144
 Gouges
 160 mm

- 17-143** 3mm
- 17-144** 5 mm



17-145
 Pato 鉗子
 185 mm



17-146
 鉗子 wit
 ratchet fixation
 40 mm



17-147
 Forcpe 付き
 170 mm



17-148
 235 mm

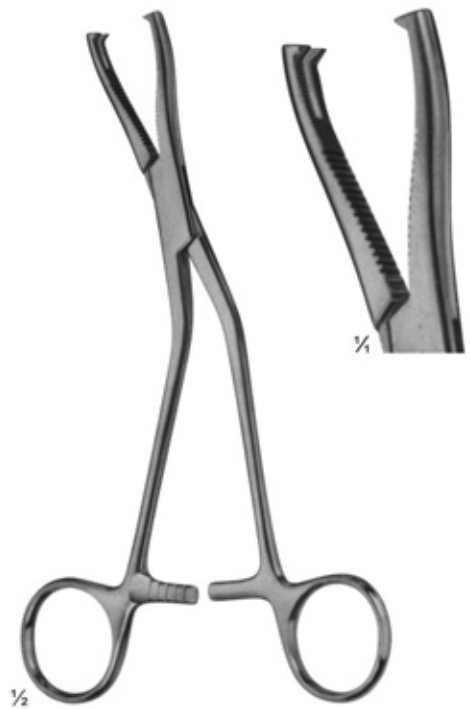

17-149
 DINGMANN
 185 mm





17-158
Wer
150 mm



17-159
WER
155 mm



17-160
BLUM耳鼻喉科HAL
155mm



17-161
BLUM耳鼻喉科HAL
180mm



17-162 - 163
JANSEN
175 mm

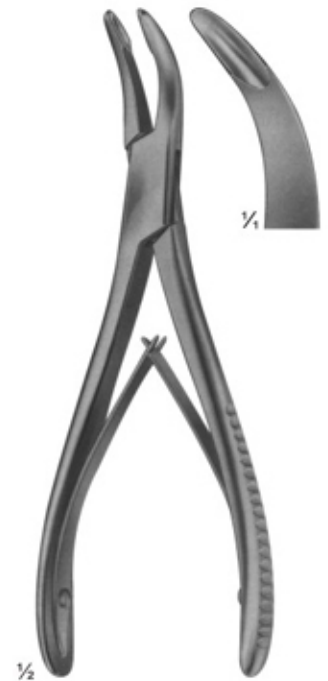

17-164
BANE-HARTMANN
175 mm



17-165
STULe
235mm



17-166
LEKSELL-STILLE
240mm



17-167
STILLE-RUSKIN
240mm

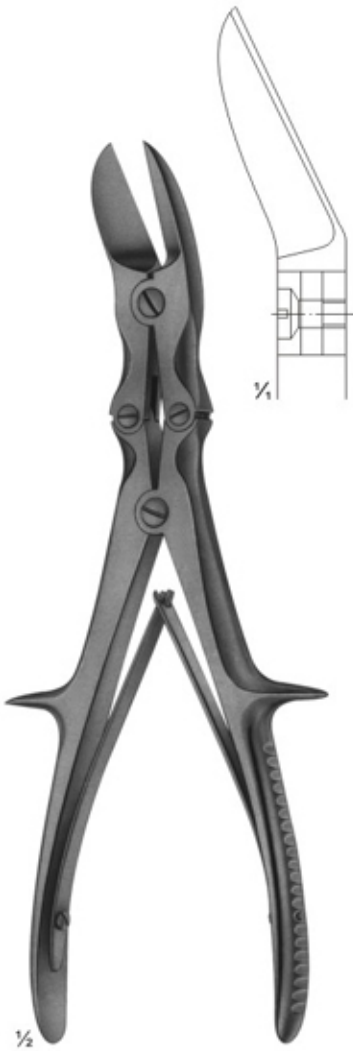

17-168
UsTON
curved on flat
20 mm

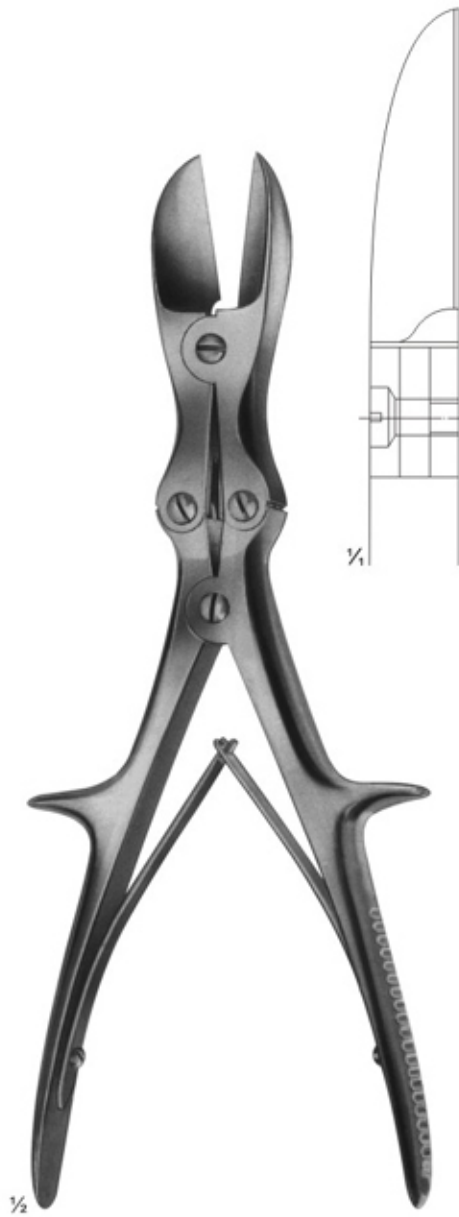

17-169
Uston
straight
280 mm

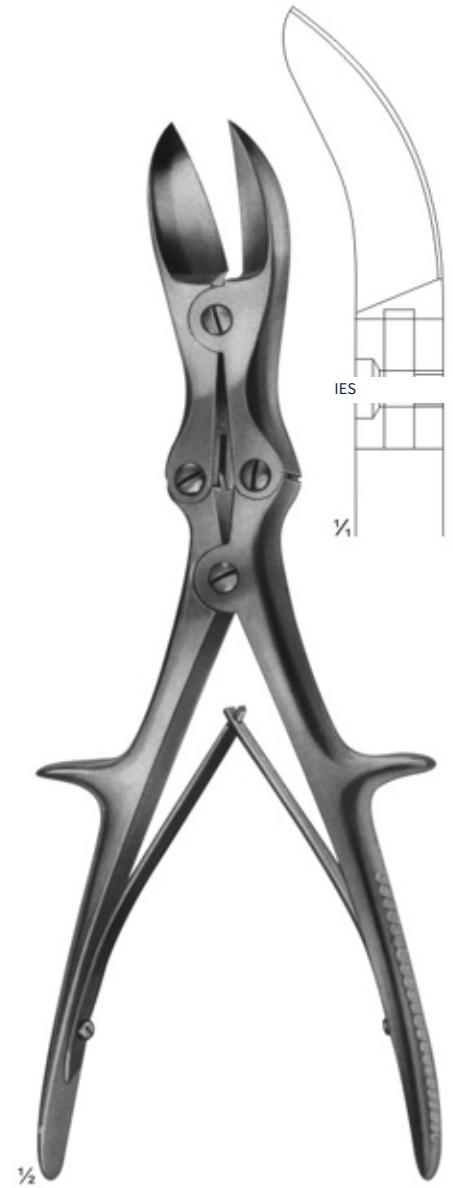

17-170
LISTON
curved on flat
20 mm