

ATRAUMATA

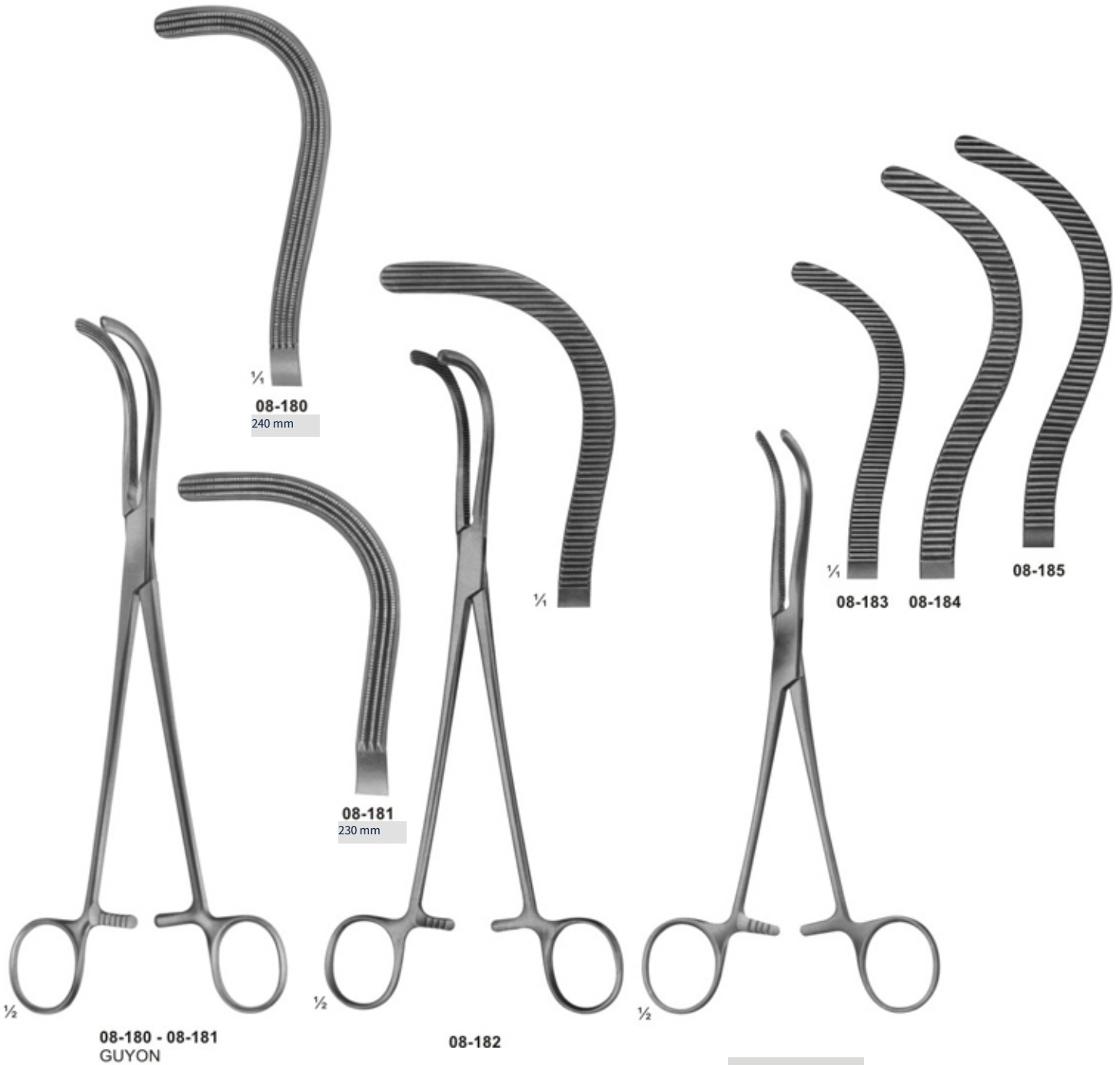

# Kidney Stone Forceps



08-186



08-187



08-188



1/4  
08-189



08-190



08-191



1/4  
08-192



1/2

08-186 - 08-189  
RANDALL  
225 mm



1/2

08-190 - 08-192  
RANDALL  
190 mm

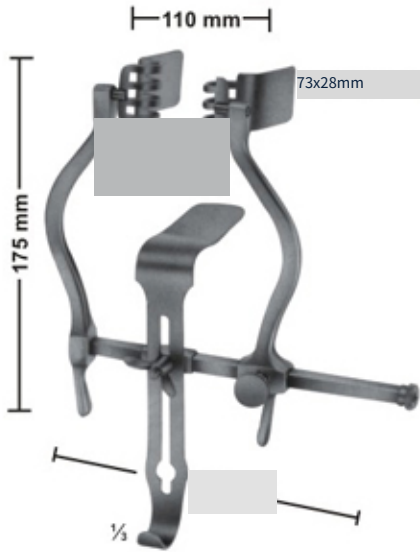

**09-101**  
JUDD-MASSON  
Bladder · suprapubic  
retractor



**09-102**  
MILLIN  
C耳鼻喉科用 bladder 用  
retro pubic prostatectomy



**09-103**  
MILLIN  
Bladder 開創器, complete  
108x45 mm



**09-104**  
LecueU  
Bladder 開創器  
80 x 31 mm



**09-105**  
KOCHER  
パチュラ

Luer Lock



**09-106**  
KLIMA ROSEGGER  
35 X 1,8 mm  
SStemal puncture 針



**09-107**  
Universal トロカール  
付き 4 tips



NELSON



**09-113 - 116**  
Inside dime. Outside dime

09-108 - 112	
Inside diam, Outside diam	
09-	30 mm
0!	40 mm
0!	
0!	
09-112	5.5mm 65mm
用 hyérocele · abdominal puncture	

09-113	2.2mm 3.0mm
09-114	3.0mm 4.0mm
09-115	40mm 50mm
09-116	6.0mm
用 abdominal puncture	
付き stop-cock · lateral 'rain	



**09-117 - 118**  
Inside diam. Outside diam  
9-117 65mm

Empyema トロカール  
BUELEU

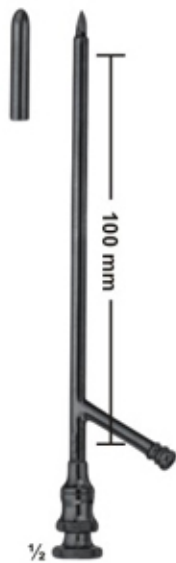

**09-119 - 122**  
Inside diam Outside diam  
09-119 3.0mm 40mm  
09-120 3.6mm 4.6mm  
09-121 4.3mm 5.3mm  
09-122 6.0mm  
Gallbladder トロカール. OCHSNER

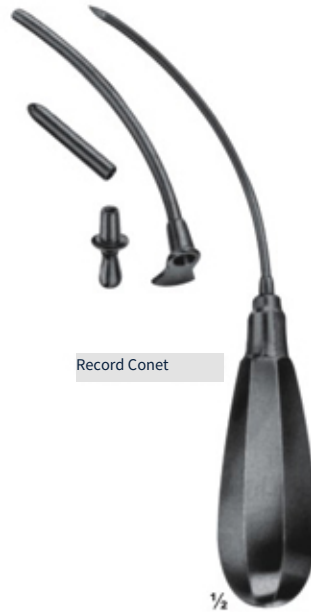

**09-123**  
PIERCE

ar



**09-124**  
COAKLEY  
Antrum トロカール  
30mm



**10-101**  
COLLIN  
用 小児用  
53x 10mm

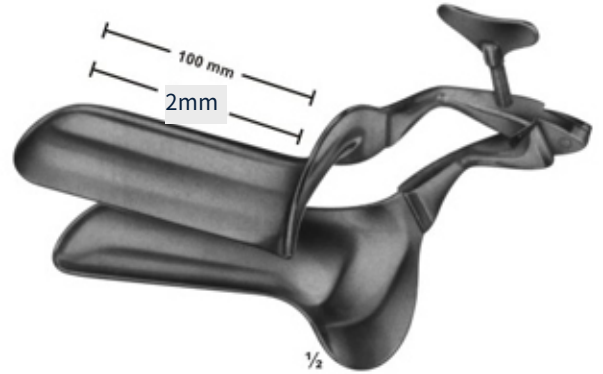

**10-102 - 105**  
COLLIN  

<b>10-102</b>	100/90mm	28mm
<b>10-103</b>	100/90mm	32mm
<b>10-104</b>	105/195mm	35mm
<b>10-105</b>	115 105mm	40 mm

 Total 全長 iworking 付き  
全長



**10-106**  
COLLIN



**10-107**  
cusco  
用 virgins  
78x17 mm



**10-108**  
cusco  
用 virgins  
75x17 mm

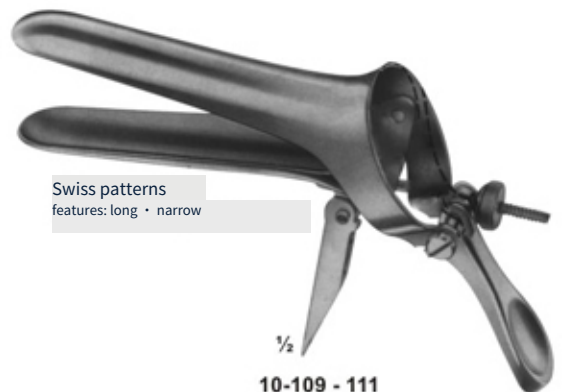

**10-109 - 111**  
cusco  

40-109	92X23-25 mm
40-110	100x25-27 mm
40-111	110327-30 mm



**10-112 - 114**

GRAVE  
10-112 75x20 mm  
40-113 95x30 mm  
10-114 105x33 mm

½



**10-115 - 116**

40-416 mm

½



**10-117 - 118**  
BRIESKY

410-197 72X25 mm 77X30 mm 140 mm  
410-118 75X30 mm 92X38 mm 170 mm

½



½

**10-119**

475 mm



½

**10-120 - 122**

SEIOL  
40-120 80X8 mm  
40-121 80X10 mm  
40-122 90X14 mm  
用 children · infants  
170mm



½

**10-123**

用小児用



½

**10-124 - 10-126**  
KRISTELLER

40-124 70X27 mm  
410-125 75X30 mm  
410-126 90X36 mm  
175mm



**10-127 - 131**  
KRISTELLER  
410-127 110X18 mm  
**10-128 110X20 mm**  
40-129 110X27 mm  
40-130 mm  
40-131 mm  
220 mm

**10-132 - 10-135**  
KRISTELLER  
上顎 blades

**10-136 - 10-139**  
KRISTELLER  
下顎 blades



1/2

**10-140 - 143**  
DOYEN  
235 mm

**10-142**  
2x45 mm

1/4

1/4

1/2

**10-143 - 10-153**  
DOYEN  
240mm

width of blades

35mm

45mm

60mm

全長の blades

60 mm

90mm

120mm

460mm

width of blades

35 mm

45mm

60 mm

**10-143**

**10-146**

**10-150**

**10-144**

**10-147**

**10-151**

**10-145**

**10-148**

**10-152**

**10-149**

**10-153**



1/2

**10-154**  
JOUL (FRIEDMAN)  
185 mm



1/2

**10-155**  
RICHTER  
470 mm



1/4



1/2

**10-156**  
GELPI  
135mm

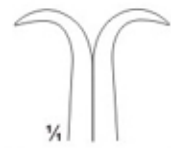

1/4



1/2

**10-157**  
GELPL  
175mm

## Uterine Dilators



½

**11-101 - 143**  
HEGAR  
with very conical point  
185 mm

11-101	1	mm	11-123	23	mm
11-102	2	mm	11-124	24	mm
11-103	3	mm	11-125	25	mm
11-104	4	mm	11-126	26	mm
11-105	5	mm	11-127	1	½mm
11-106	6	mm	11-128	2	½mm
11-107	7	mm	11-129	3	½mm
11-108	8	mm	11-130	4	½mm
11-109	9	mm	11-131	5	½mm
11-110	10	mm	11-132	6	½mm
11-111	11	mm	11-133	7	½mm
11-112	12	mm	11-134	8	½mm
11-113	13	mm	11-135	9	½mm
11-114	14	mm	11-136	10	½mm
11-115	15	mm	11-137	11	½mm
11-116	16	mm	11-138	12	½mm
11-117	17	mm	11-139	13	½mm
11-118	18	mm	11-140	14	½mm
11-119	19	mm	11-141	15	½mm
11-120	20	mm	11-142	16	½mm
11-121	21	mm	11-143	17	½mm
11-122	22	mm			



½

**11-144 - 152**  
HEGAR  
205 mm

11-144	1+2	mm
11-145	3+4	mm
11-146	5+6	mm
11-147	7+8	mm
11-148	9+10	mm
11-149	11+12	mm
11-150	13+14	mm
11-151	15+16	mm
11-152	17+18	mm

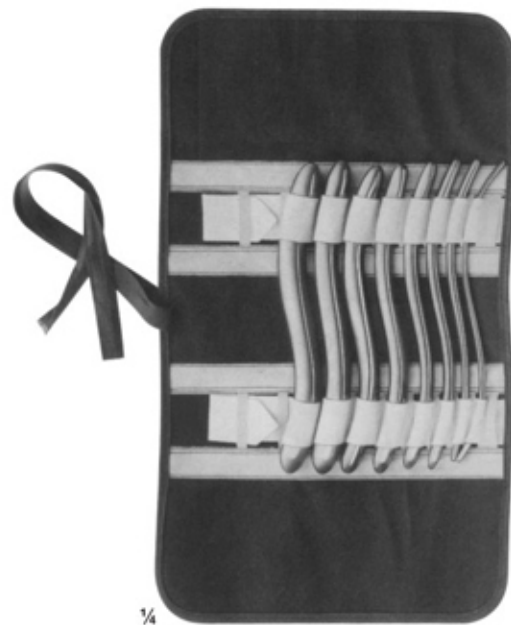

¼

**11-153**  
HEGAR  
Uterine dilator set, in canvas  
roll with 8 dilators.



**11-154**  
MAYO  
malleable



**11-155**  
SIMS  
malleable  
5330 mm



**11-156**  
MARTIN  
330 mm



**11-157**  
SIMPSON  
malleable  
silver-plated  
290 mm



**11-158**  
BRAUN  
子宮用  
depressor  
270mm



**11-159**  
コットン  
applicator  
270 mm



**11-160**  
PELKMANN  
260 mm



**11-161**  
PELKMANN  
260 mm

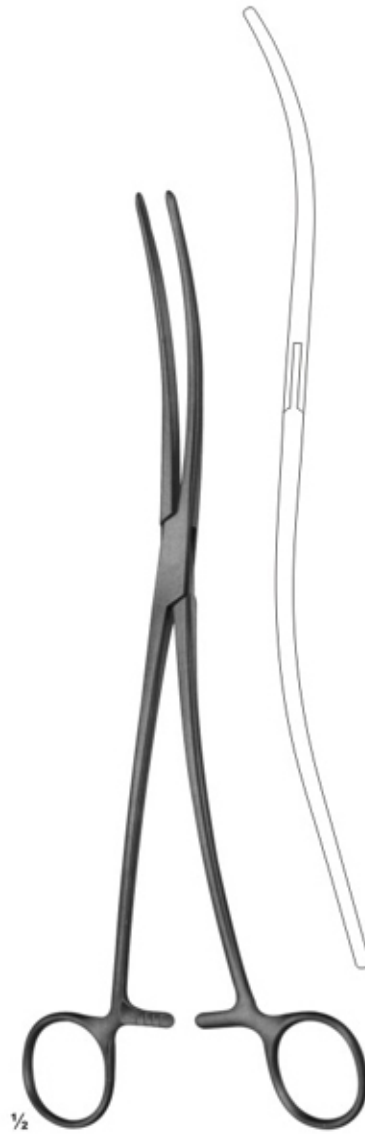

**11-162**  
BOZEMANN  
250 mm



**11-163**  
BOZEMANN  
255 mm

Jaws 付き longitudinal groove

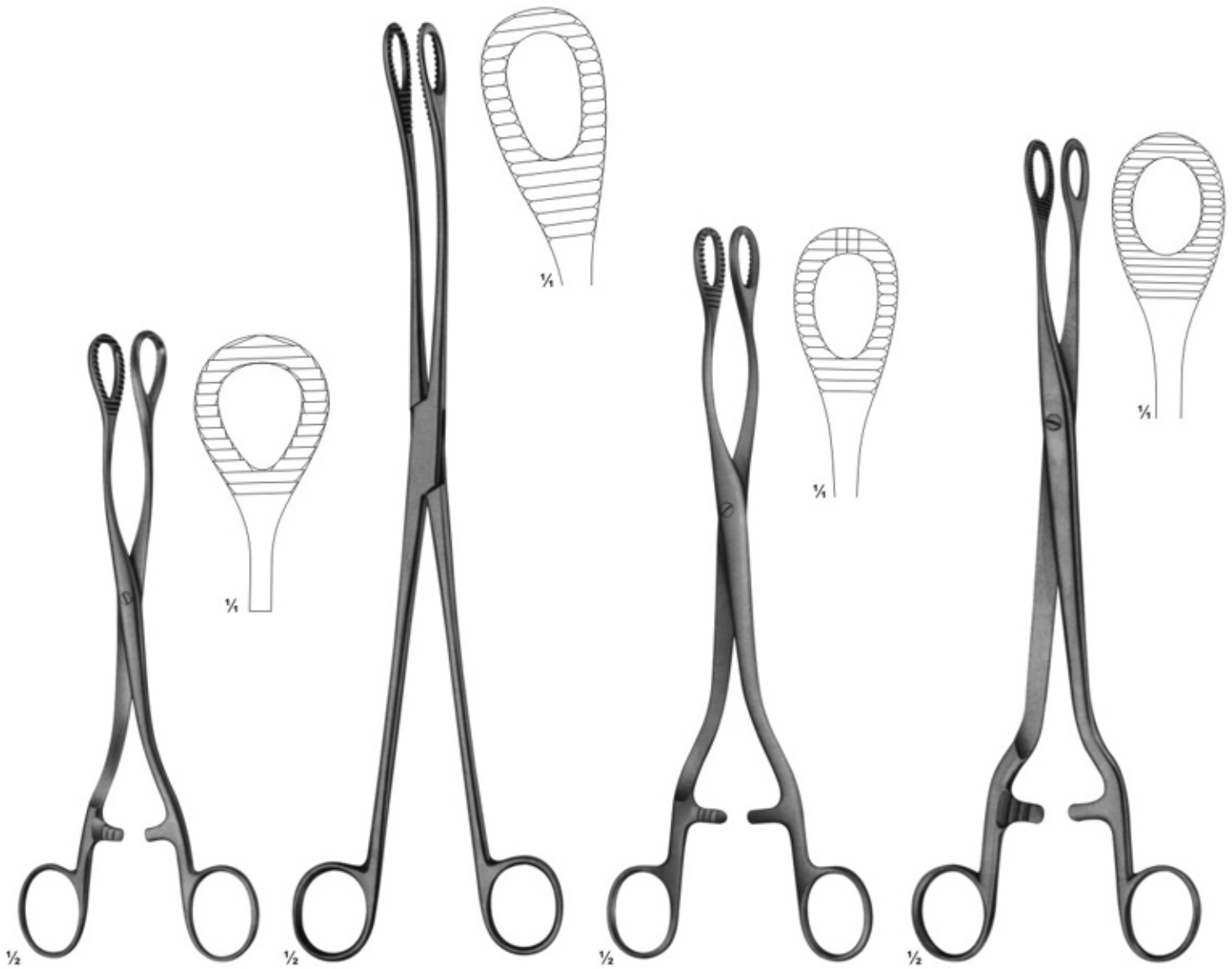

**11-164**  
HEYWOOD-SMITH  
200 mm

**11-165**  
KELLY  
320mm

**11-166**  
HEYWOOD-SMITH  
250 mm

**11-167**  
NOTO  
280 mm



**12-101**  
Langebeck  
13 cm / 5 1/8"

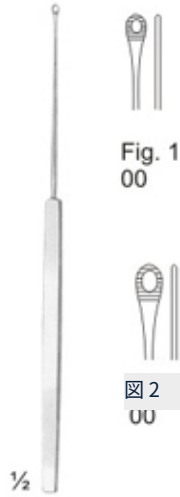

**12-102**  
Shapleigh  
15 cm / 5 1/8"

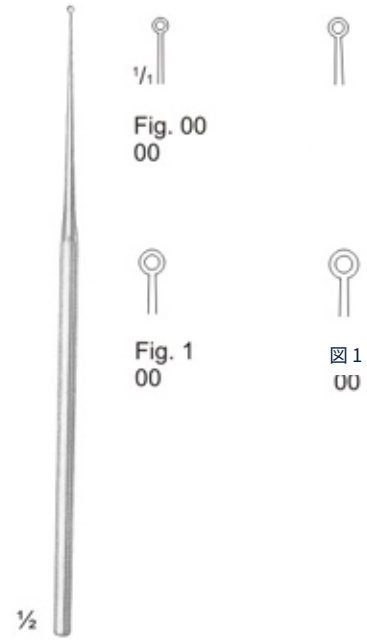

**12-104**  
Buck  
15 cm / 6 6/8"

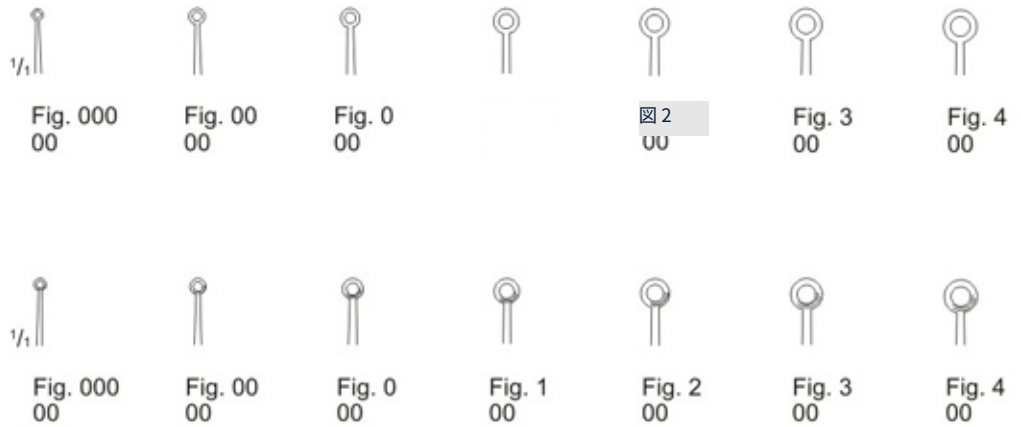



**12-105**  
ASCH  
子宮用  
'Secretion scoop  
200 mm



**12-106**  
子宮用  
Secretion scoop)  
270mm



**12-107**  
NOVAK-SCHOECKAERT  
Endometrial biopsy  
curette  
240 mm



**12-108**  
RANDALL  
Endometrial  
biopsy curette  
240 mm



**12-109**  
Hartmann-Wiilsein  
shat 全長  
85mm

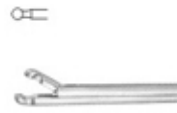

**12-110**  
Hartmann-Wullstein  
shaft length  
85mm



saat  
Hartmann  
shaft 全長  
85mm



**12-112**  
Hartmann  
shaft length  
85 mm

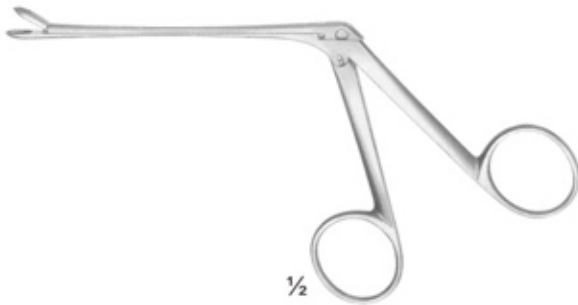

$\frac{1}{2}$   
**12-109 - 12-119**

**12-113**  
14 cm / 5 4/8"  
jth

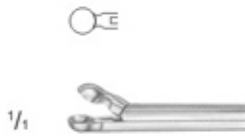

**12-114**  
Hartmann-Herzfohl  
20mm  
'shaft 全長  
'5mm



**12-115**  
Hartmann  
3mm  
'shaft 全長  
85mm

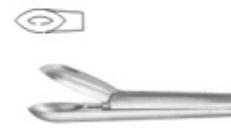

**12-116**  
shaft全長  
85mm



**12-117**  
Hartmann-Hoffmar  
20mm  
85mm

**12-118**  
25mm  
85mm

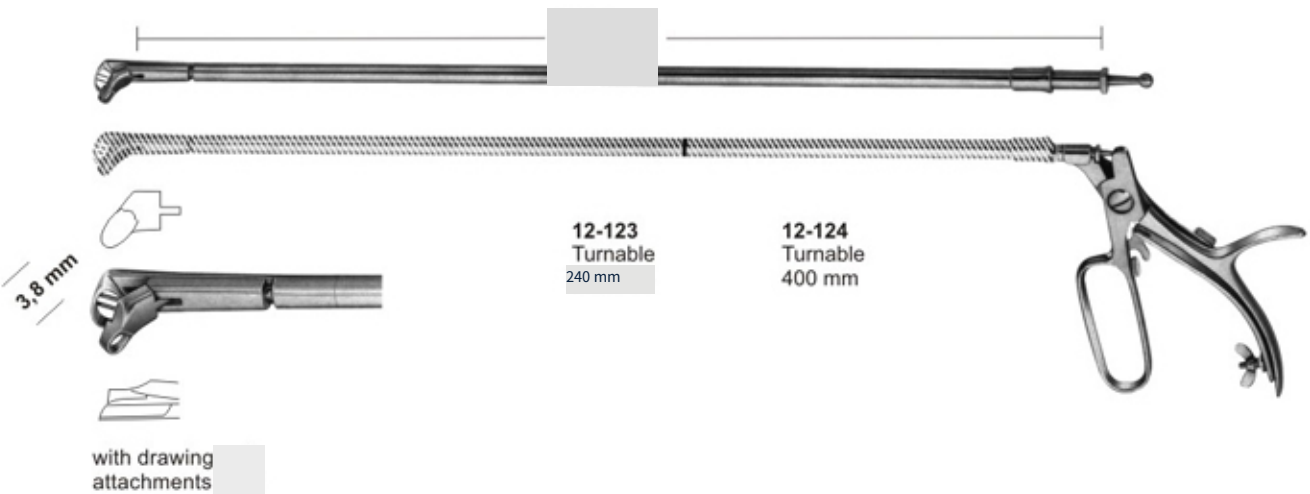
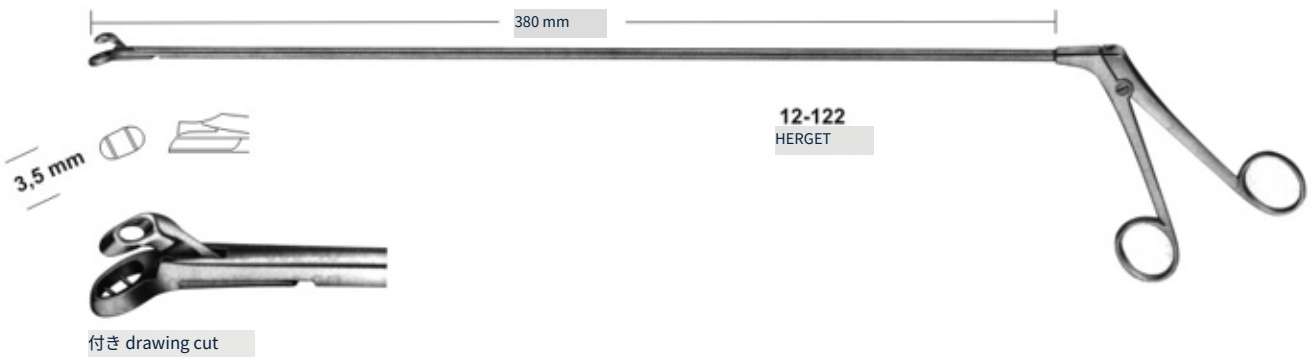
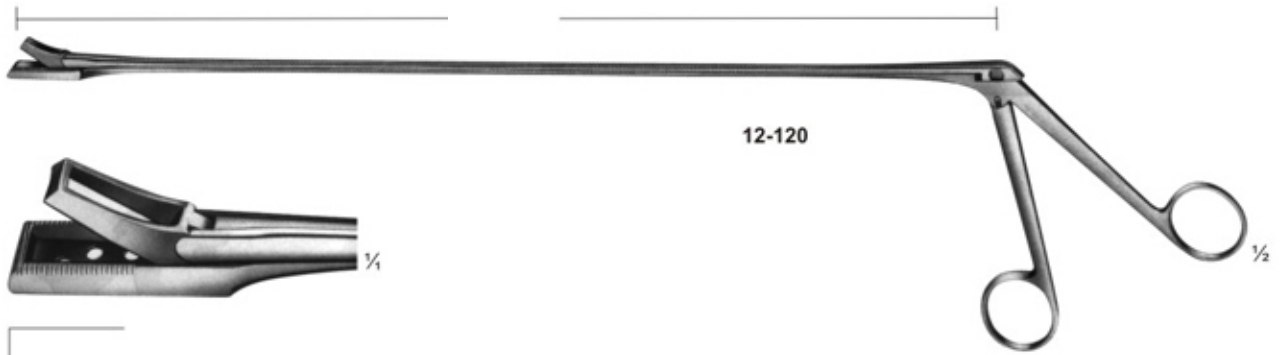

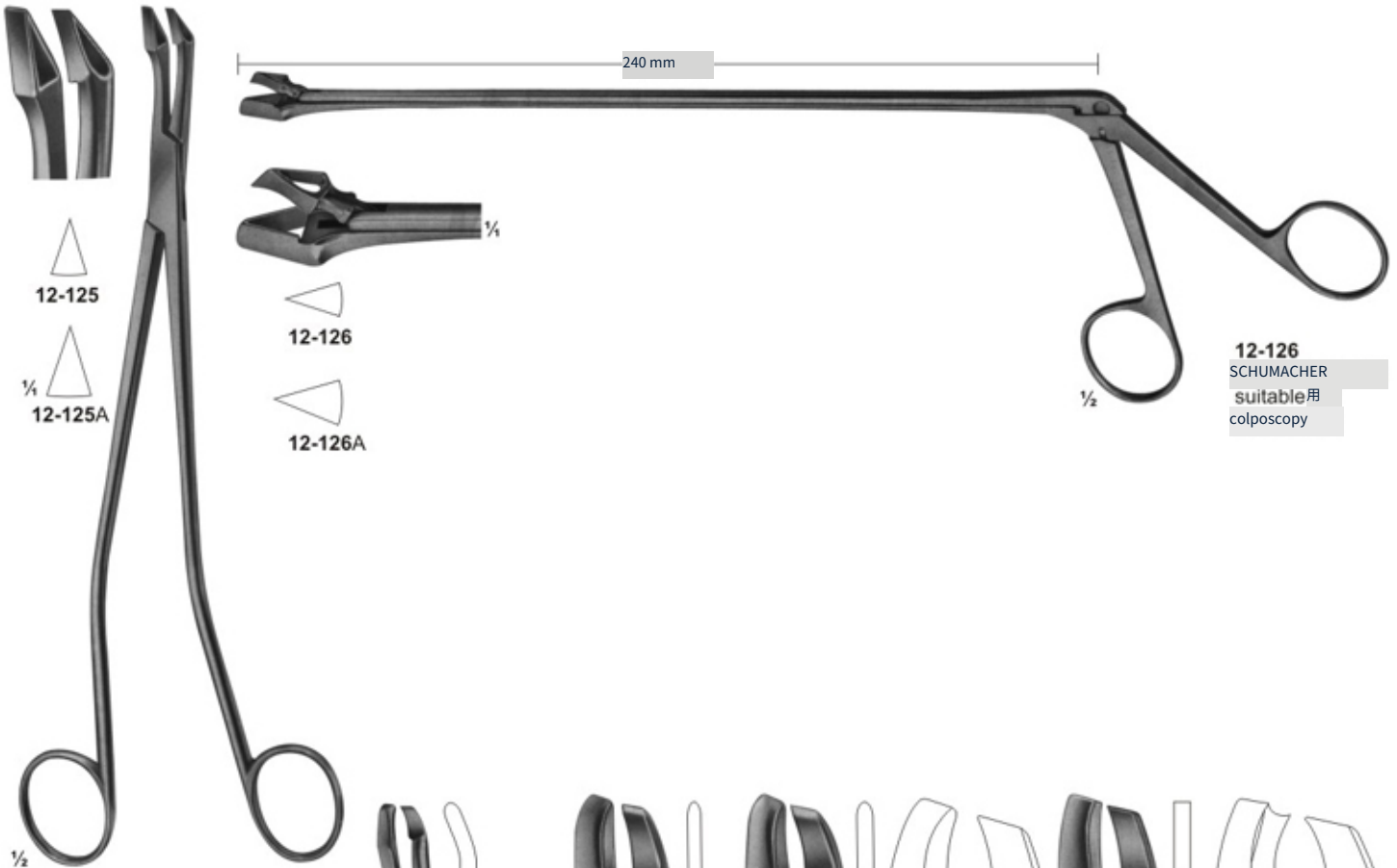

12-125

12-125A

12-126

12-126A

**12-126**  
SCHUMACHER  
suitable用  
colposcopy

**12-125**  
SCHUMACHER  
240mm

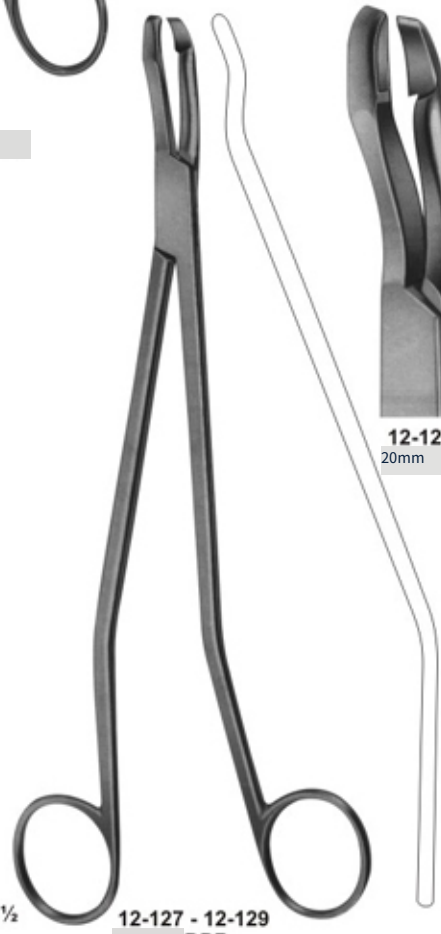

**12-127 - 12-129**  
SEIDL DBP

240mm



**12-127**  
20mm



**12-128**  
24mm



**12-129**  
24mm



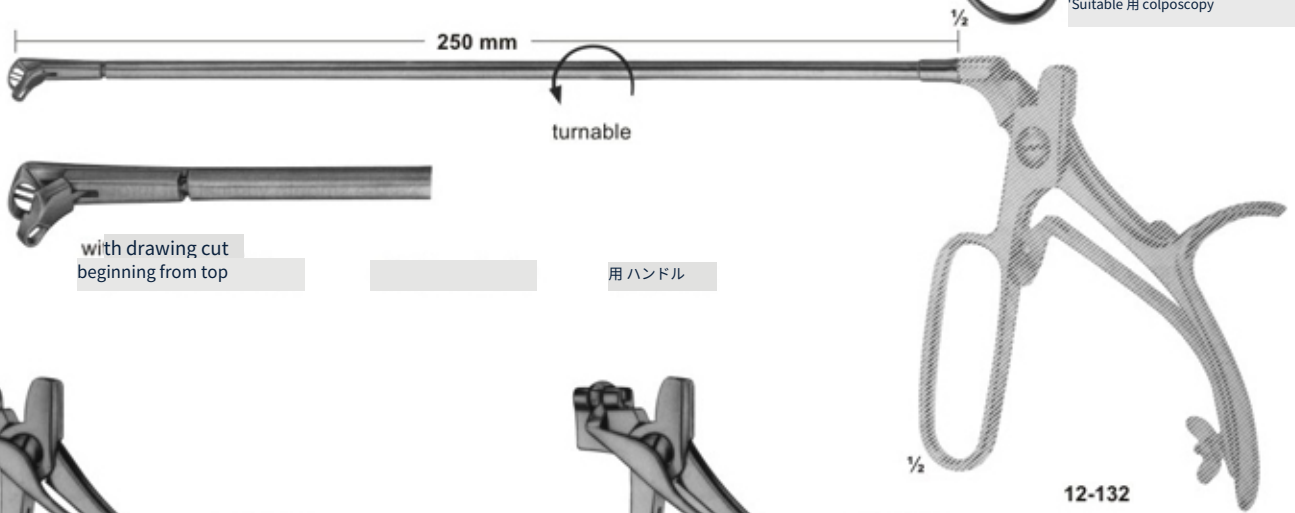

with drawing cut  
beginning from top

用ハンドル

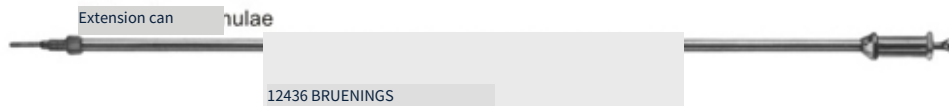

12438 Biopsy tip

付き drawing cut



1/2  
**12-140**  
SIMON  
240 mm

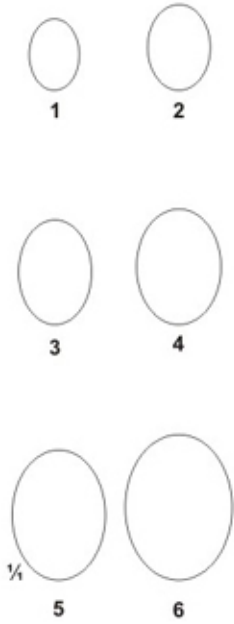

1/2  
**12-141**  
SCHROEDER  
310 mm

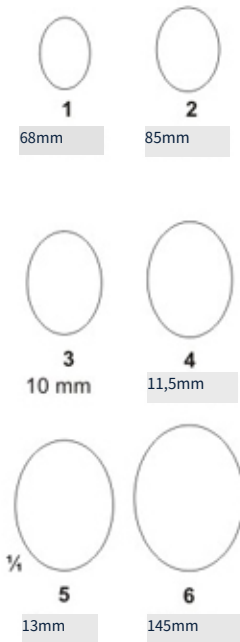

68mm

85mm

10 mm

11,5mm

13mm

145mm



1/2  
300 mm

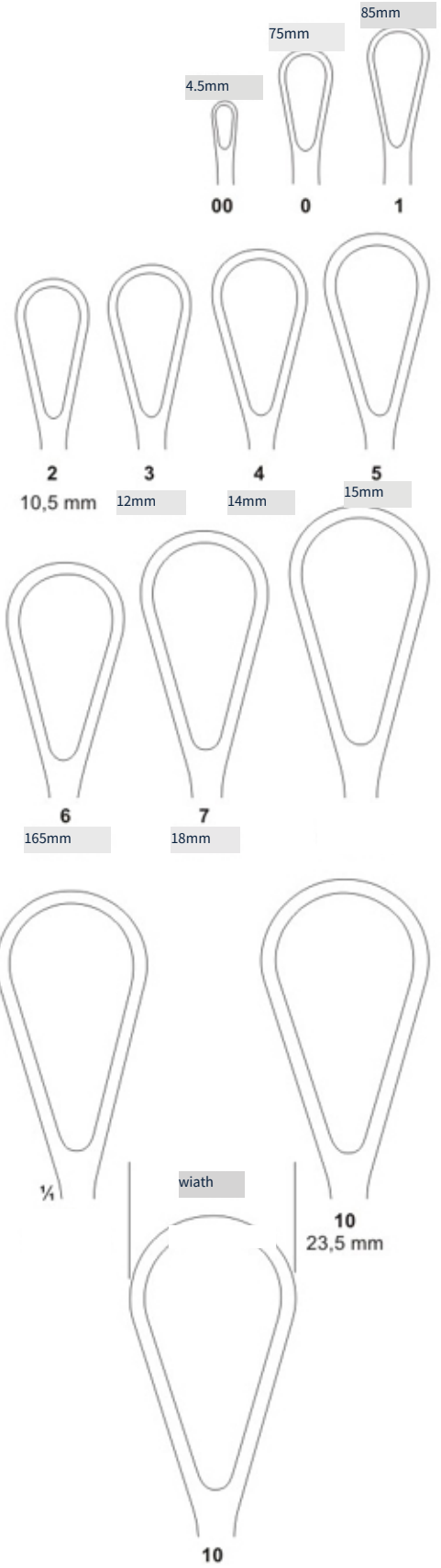



**13-101**  
NAEGELE  
355 mm



**13-102**  
NAEGELE  
400 mm



**13-103**  
SIMPSON-BRAUN  
305mm



Fig: 1  
13-104

Fig: 2  
13-105

Fig: 3  
13-106

Fig: 1  
13-107

Fig: 3  
13-109

13-104 - 106  
WINTER  
290 mm

13-107 - 109  
WINTER  
290 mm

13-110  
SAENGER  
275 mm



**13-111**  
BOSE  
165 mm



**13-112**  
BOSE  
165mm



**13-113**  
sharp



**13-114**  
blunt



**13-115**  
stumpffblunt



**13-116**  
FINSEN  
50mm



**13-117**  
FINSEN  
70mm

15

LAd

TROUSSEAU  
120 mm

LABORDE  
125 mm

LABORDE  
strong pattern  
435mm



**13-121**  
Cleaning Brush  
用 tracheal 管  
285 mm



# fill



saat  
1.5mm 15mm

1/2  
**14-111 - 112**  
200 mm



1/2  
**14-113 - 116**  
DE BAKEY

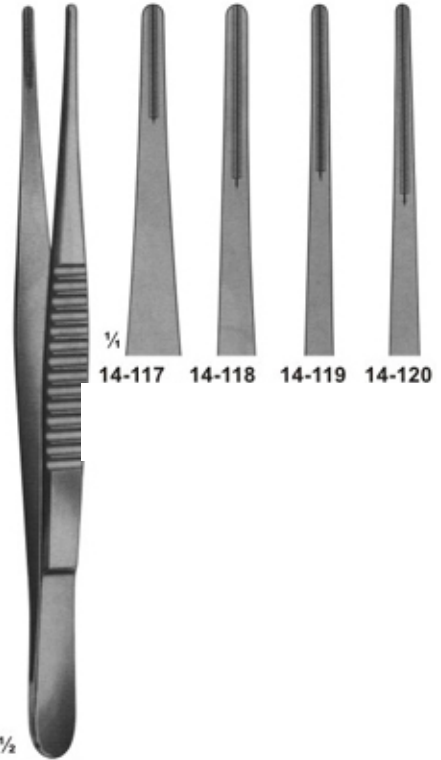

1/4  
**14-117 14-118 14-119 14-120**

1/2  
**14-117 - 120**  
DE BAKEY

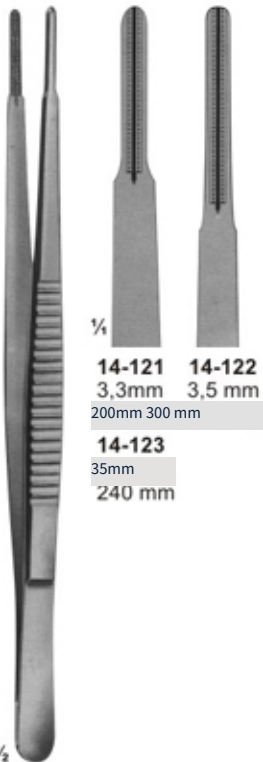

1/4  
**14-121 14-122**  
3,3mm 3,5 mm  
200mm 300 mm  
**14-123**  
35mm  
240 mm

1/2  
**14-121 - 123**  
DE BAKEY

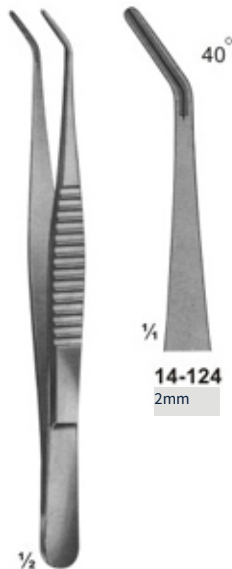

1/2  
**14-124**  
DE BAKEY  
150mm

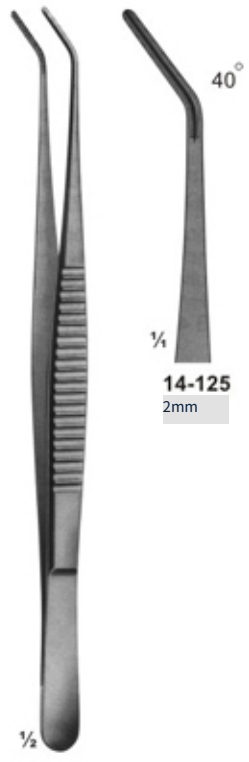

1/2  
**14-125**  
DE BAKEY  
200 mm