

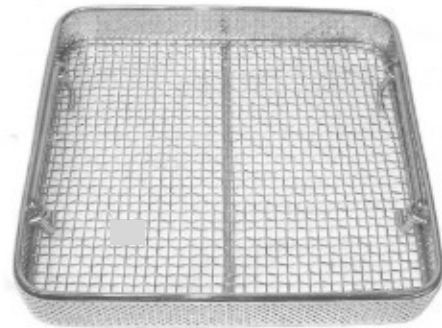

2948
Instrum耳鼻咽喉科sトレーの20 Pes



2951
Instruments Riddle



2949
Instrum耳鼻咽喉科sトレーの7 Pes



2949-A
Instrum耳鼻咽喉科sトレーの10 Pes



2950
Instruments

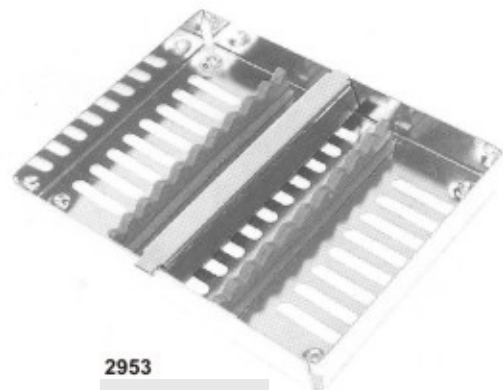
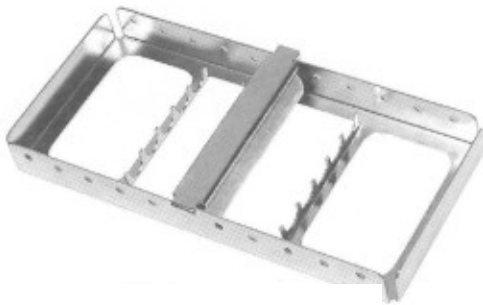

2953



2954
InstrumentsTay
Perforated



2955
Perforated Base



2956
Instrumentsトレー
Sobd Base

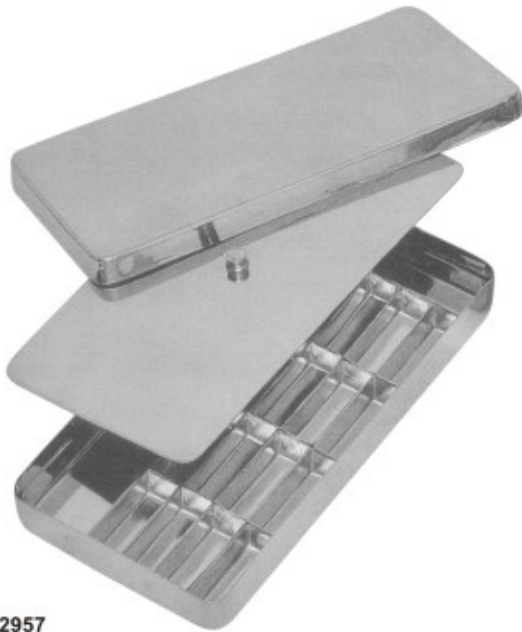

2957
Pulpectomy トレー



2958
Sterilizing Box
Available Sizes:
17x17x3 cm
20x10x6 cm
30x14x6 cm



2959
Endo トレー Box



2960
Finger Cup



2961
Bur Box

2962
Sterilizing Drum
150x150mm
175x175mm
190x190mm
200x140mm
200x200mm
240x120mm
225x225mm
240x240mm
290x160mm



2963
Sterilizing Drum
280x240mm
230x150mm
300x250mm
340x160mm
350x250mm
390x200mm
380x300mm
100x100mm
150x120mm



2964
Instruments Box



2965
Instruments Box



2966
Instru



2967
Instruments Sterilizer
150x75 mm



2968
Endodontic Box



2969
Sterilizing Box
320x120 mm



Instruments Tray



Instruments Tray



2972
Instruments Tray
(Perforated)



2973
Instruments Tray
Shallow(Mayo)



2974
Scaler Tray
20x100 x 1.5 cm



2975
Scalers Tray



2976
Scalers Tray



2977

2978

2979

2980

Forcep · Thermometer Jars



2982

Spitten Mug



2983

Spirit
Stainless Steel 18 1
Capacity: 150



2984

Spit Burner
Stainless Steel 18 10
Capacity: 70ml



2985

ドレッシング Jar



2986

ドレッシング Jar



2987

Irrigator(DouchCan)



2988

Measuring Jug



2989
Sponge Bow



2990
Wash Basin
300mm-350mm-400mm



2991
Sponge Bow



2993
Medicine Cop



2995
Kidney トレー Shallow
150mm-200mm-240mm-300mm



00mm

150mm-200mm-250mm-300mm



2999
Noedle Case Rectangle
針 Case Round 付き Cover
90x15



3000
Dustbin Without Stand
6-10-12 Ltr



3001
管 Rack, Round Model
Stainless Stool 18 10



3002



3003
Lotion Bow With Lip
40-60-80-100-120-150-180-200mm



3004
Standard

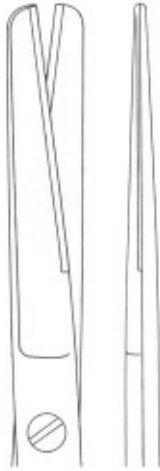

145mm
16,5cm
18,5cm



3005
Standard

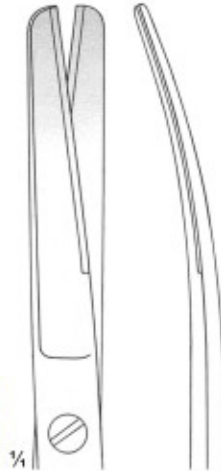

14,5mm
16,5cm
18,5cm



14,5cm
16,5cm
18,5cm



3007
Standard



145mm
16,5cm
18,5cm



3008
Standard



140mm
16,5cm
18,5cm



3009
標準



145mm
16,5cm
18,5cm

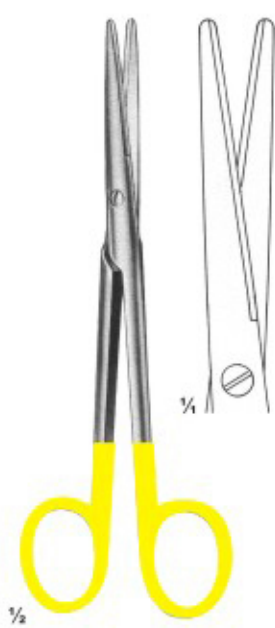

3010
MAYO-LEXER
Straight
16 cm

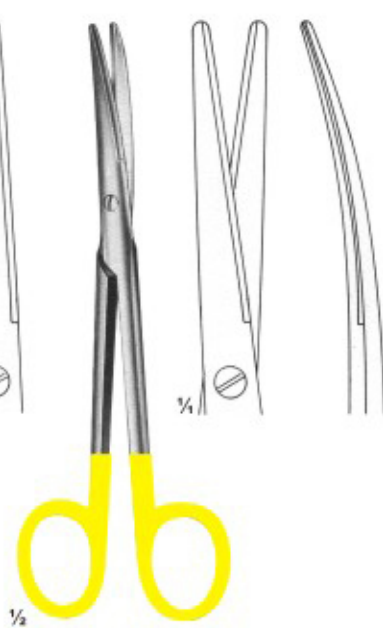

3011
MAYO-LEXER
Curved
16m



3012
LEXER
Straight
16, 21 cm

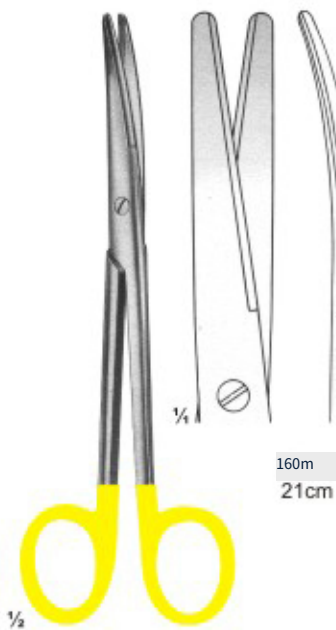

3013
LEXER
Curved
16, 21 cm

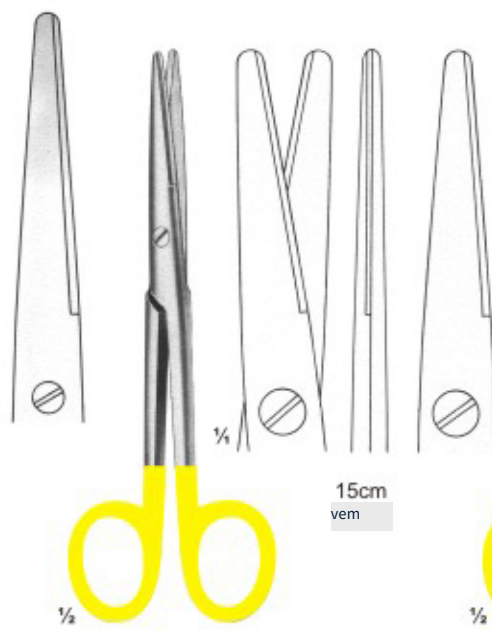

3014
MAYO-STILLE
Straight
15,17 cm

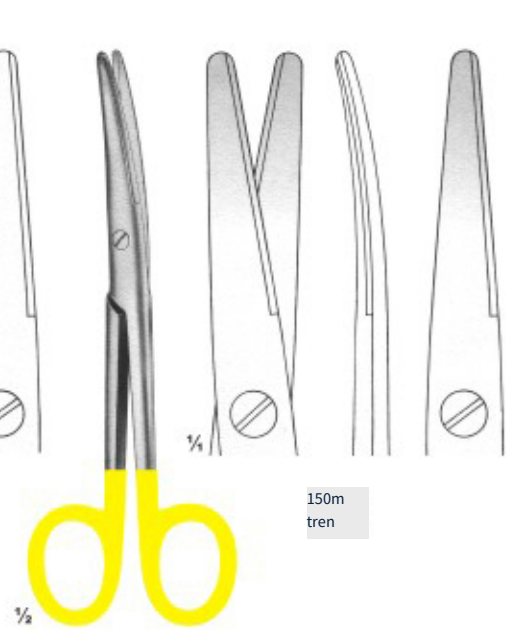

3015
MAYO-STILLE
Curved
15,17 cm



20cm
280m
300m

14,5cm
23,5cm
25,50m

3016
METZENBAUM
Straight

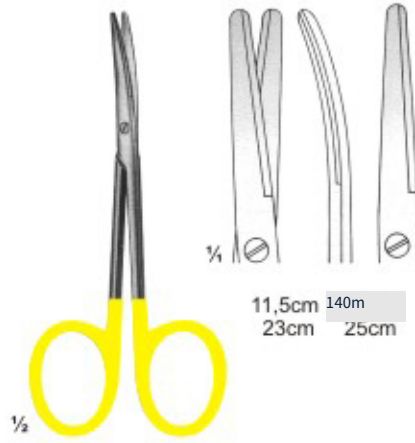

11,5cm
23cm

140m
25cm

3017
METZENBAUM
Curved

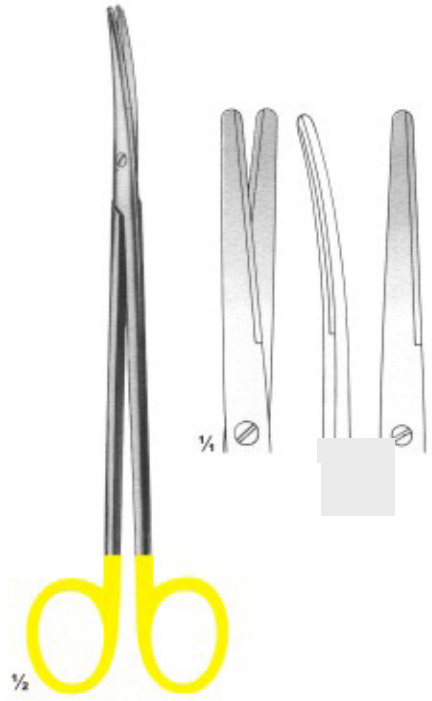

3018
METZENBAUM
Curved



186m

20cm
28cm

3019
METZENBAUM FINO
Straight

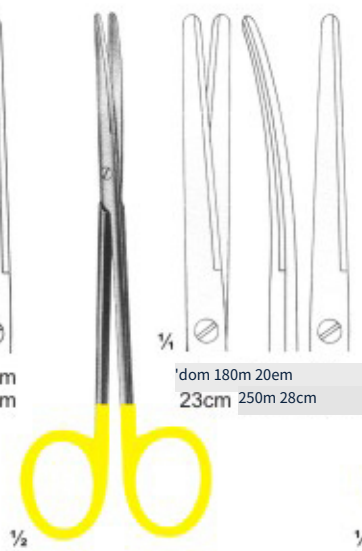

180m 20cm
23cm 250m 28cm

3020
METZENBAUM FINO
Curved



14cm 18m
20cm 23m

3021
METZENBAUM FINO
Sharp

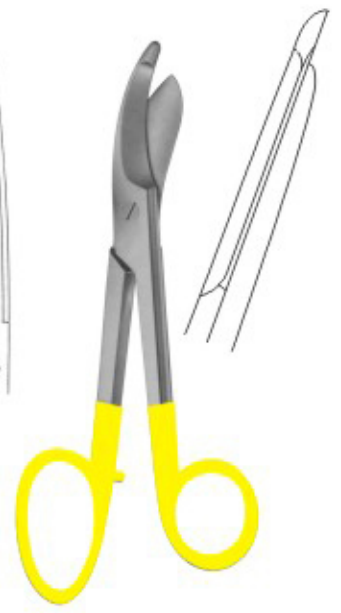

3022
BRUNS
235 mm

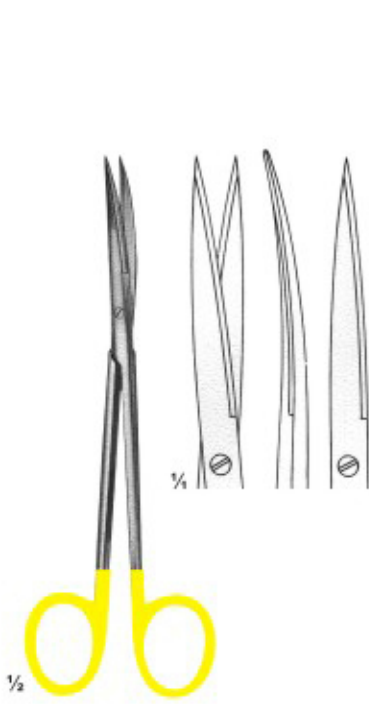

3023
METZENBAUM FINO

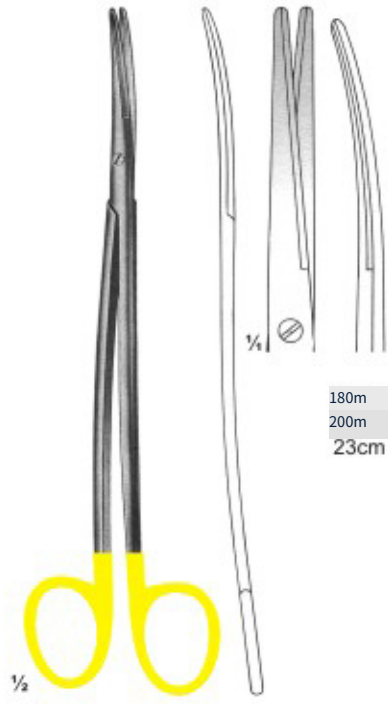

180m
200m
23cm

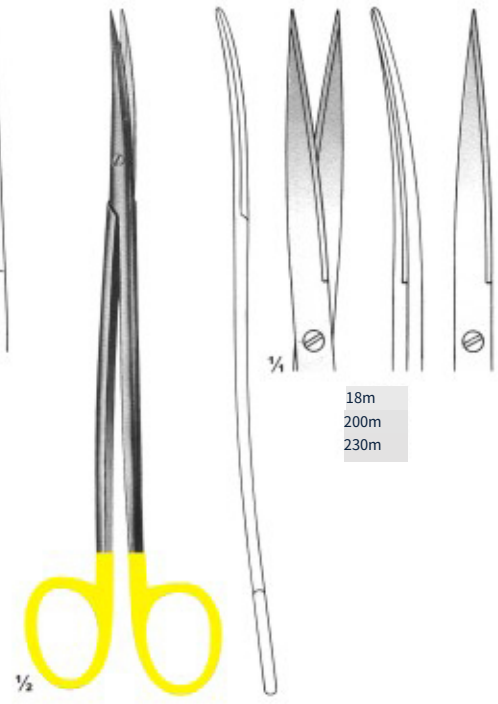

18m
200m
230m

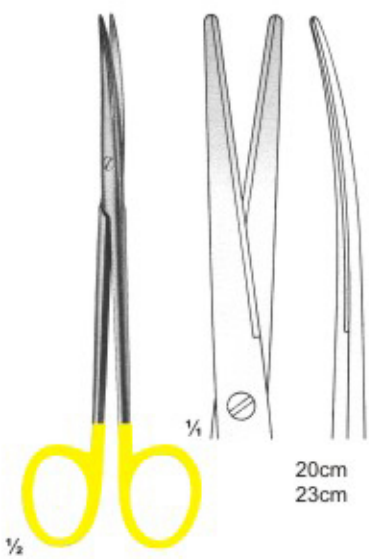

20cm
23cm

3026
METZENBAUM FINO

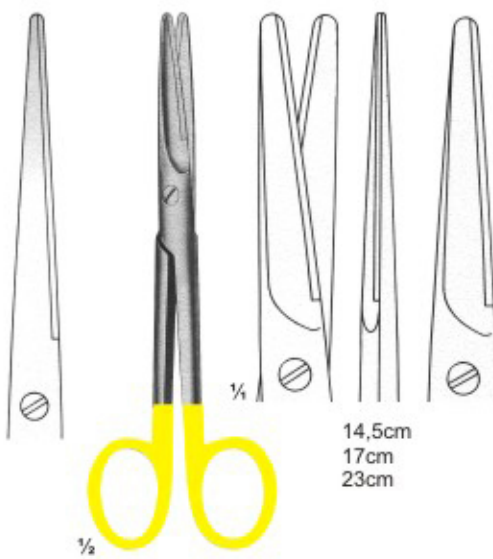

14,5cm
17cm
23cm

3027
MAYO
直

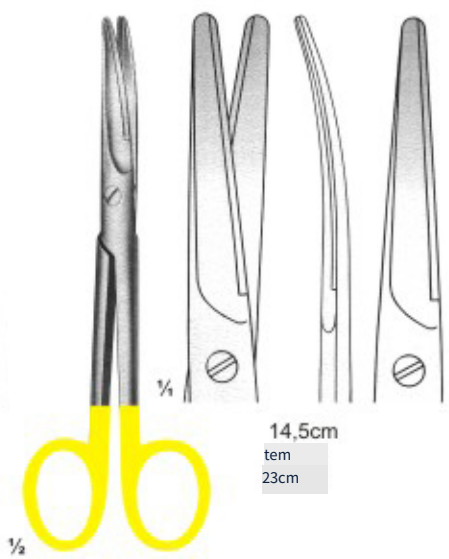

14,5cm
20cm
23cm

3028
MAYO
曲



3029
SMS

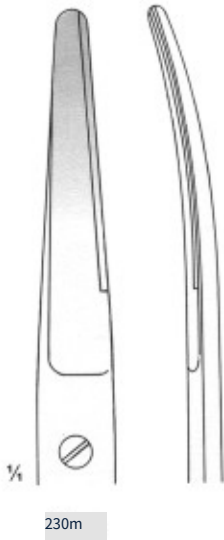

230m

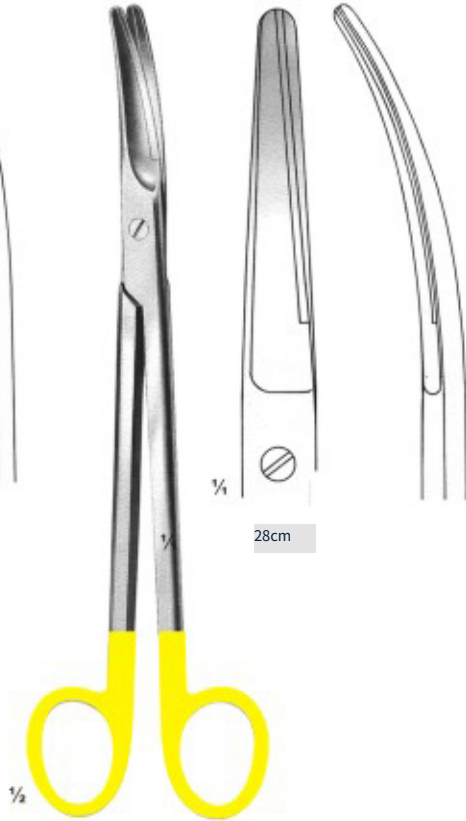

3030
PARAMETRIUM

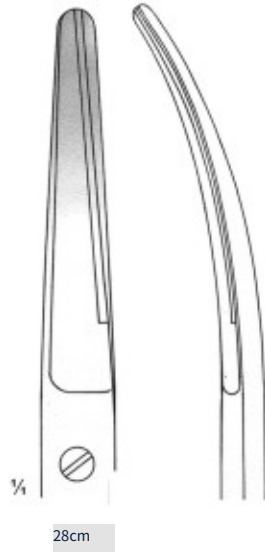

28cm

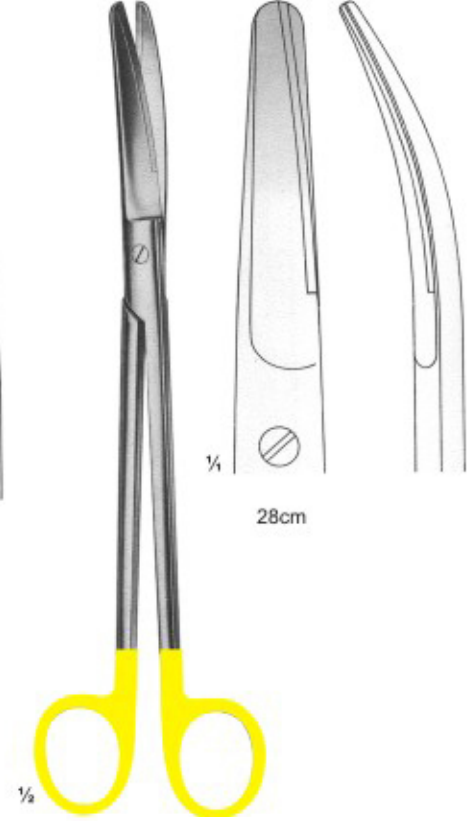

3031
MAYC

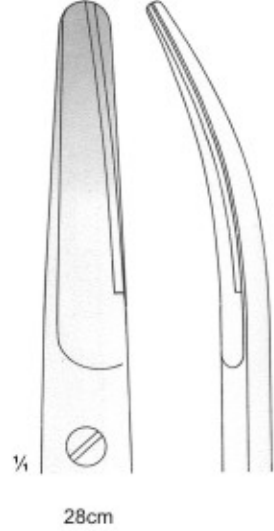

28cm



3032
KELLY
Straight 18cm



3034
DEAN
17 cm



3035
LAGRANGE
Double-曲
11.5 cm

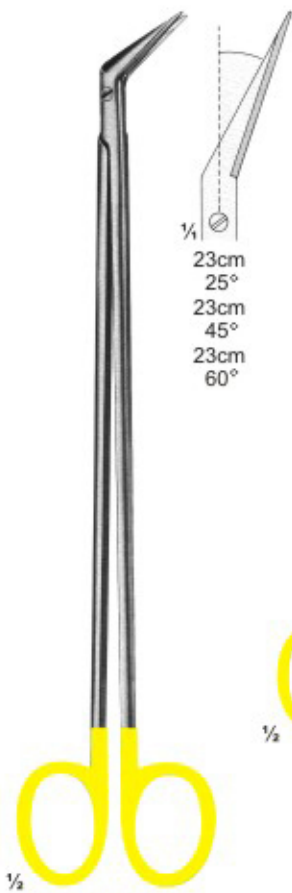

3036
DE-BAKEY



3037
DE-BAKEY

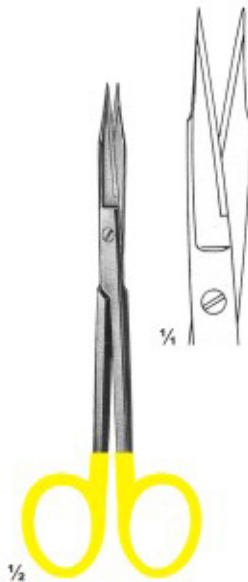

3038
GOLDMAN Fox
13 cm



3039
GOLDMAN Fox
Double-曲
130m

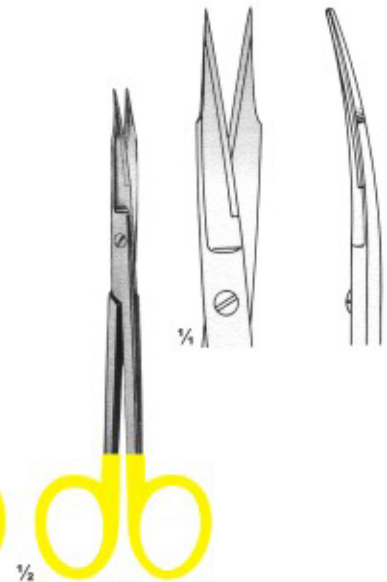

3040
GOLDMAN Fox
13 cm

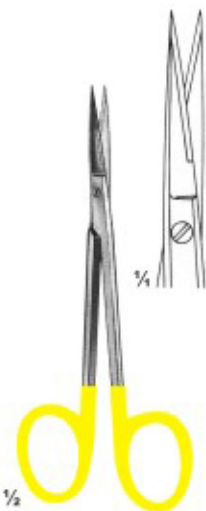

直
11,5 cm

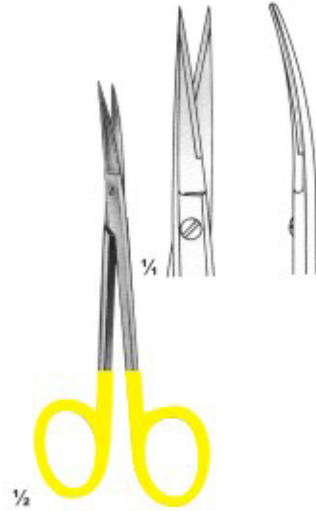

3042
細型 ハサミ
曲
11,5 cm

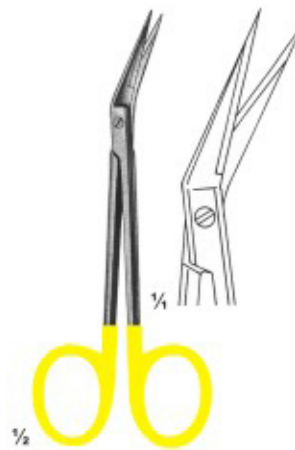

3043
細型 ハサミ
Angled
11,5 cm



3044
RAGNELL
Cured
12 cm

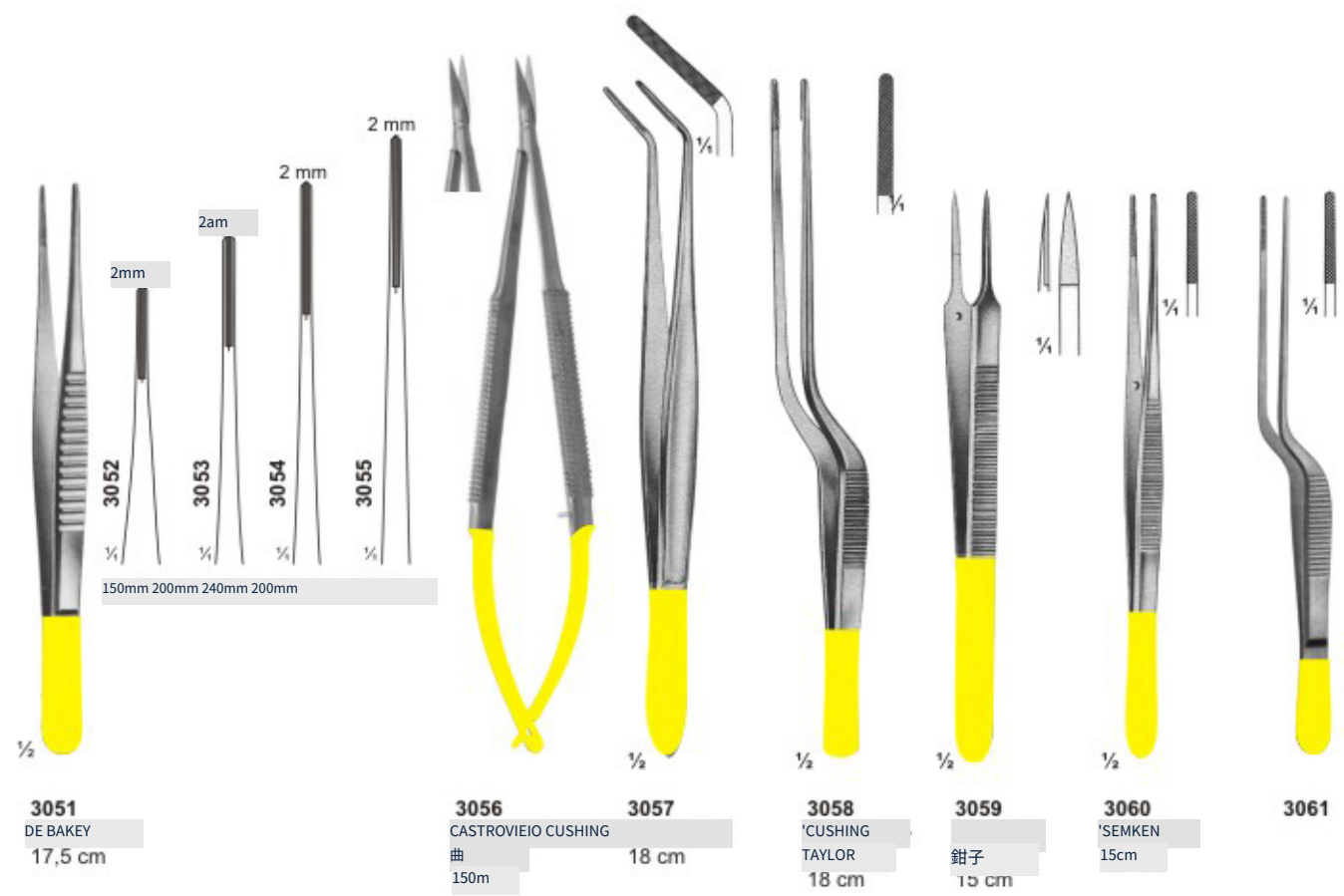
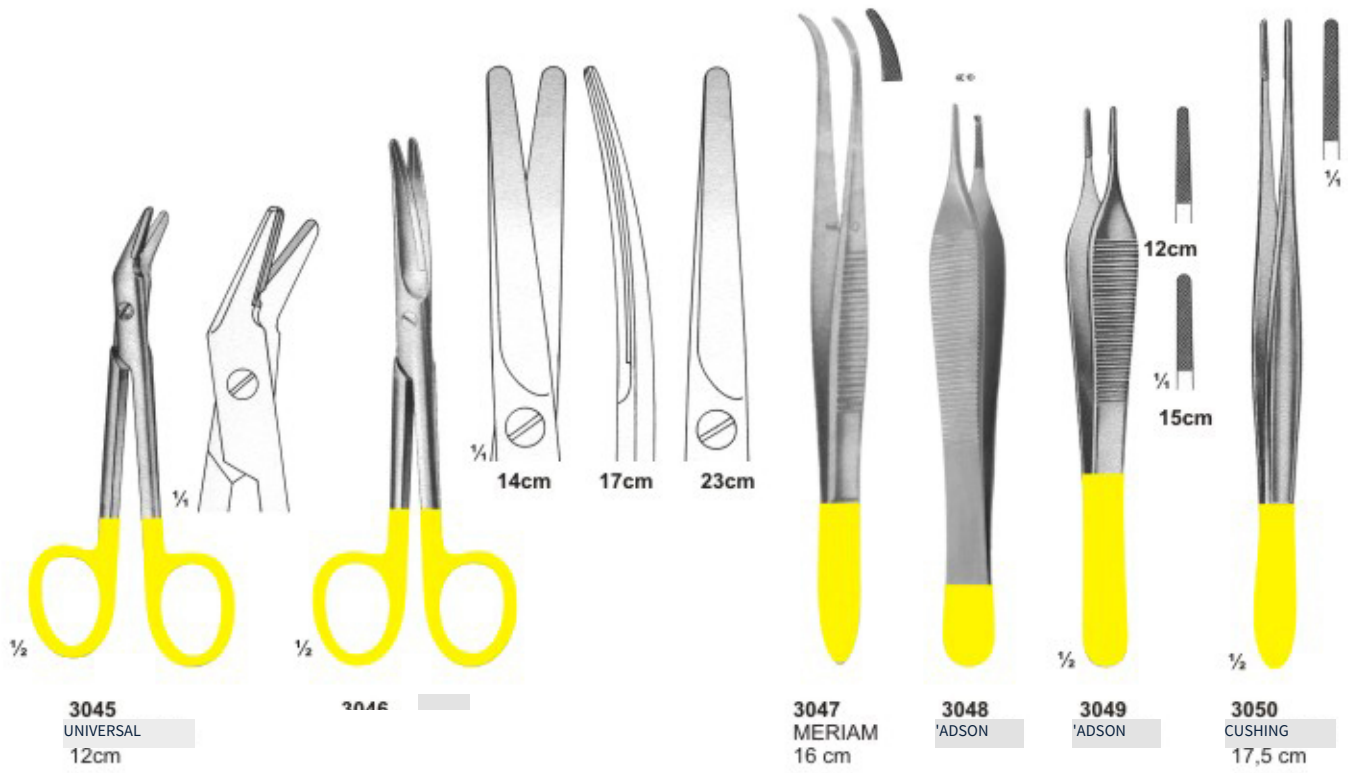



3062
WANGENSTEEN

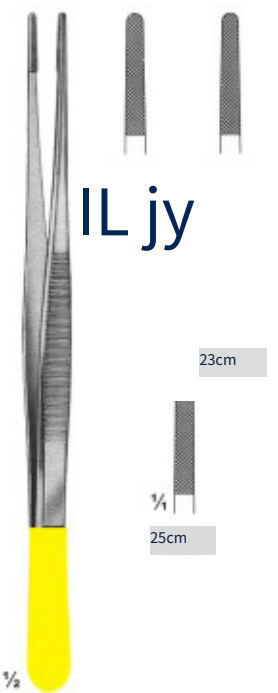

3063
POTTS-SMITH

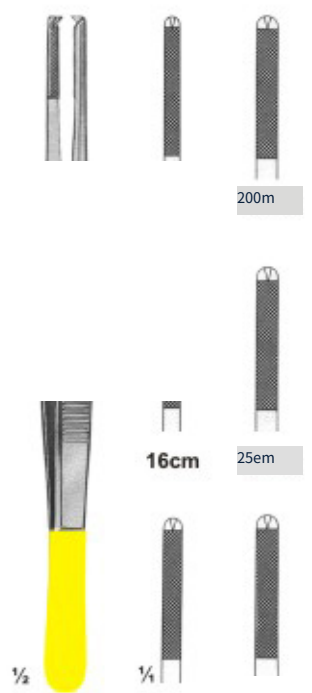

3064
OEHLER



3065
POTTS-SMITH



3066
ARRUGA
16 cm



3067
HEPP
SCHEIDLE
18 cm



3068
KALT
付き caTch
135 mm



3069
CASTROVIEJO
直
14 cm



3070
CASTROVIEJO



3071
CASTROVIEJO



3072
CASTROVIEJO
Curved
14 cm

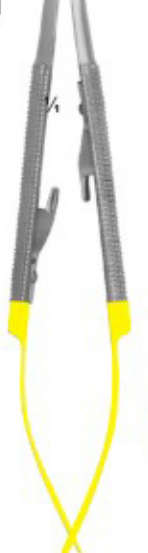

3073
CASTROVIEJO
Straight



3074
CASTROVIEJO
Straight

IL jy

'MII

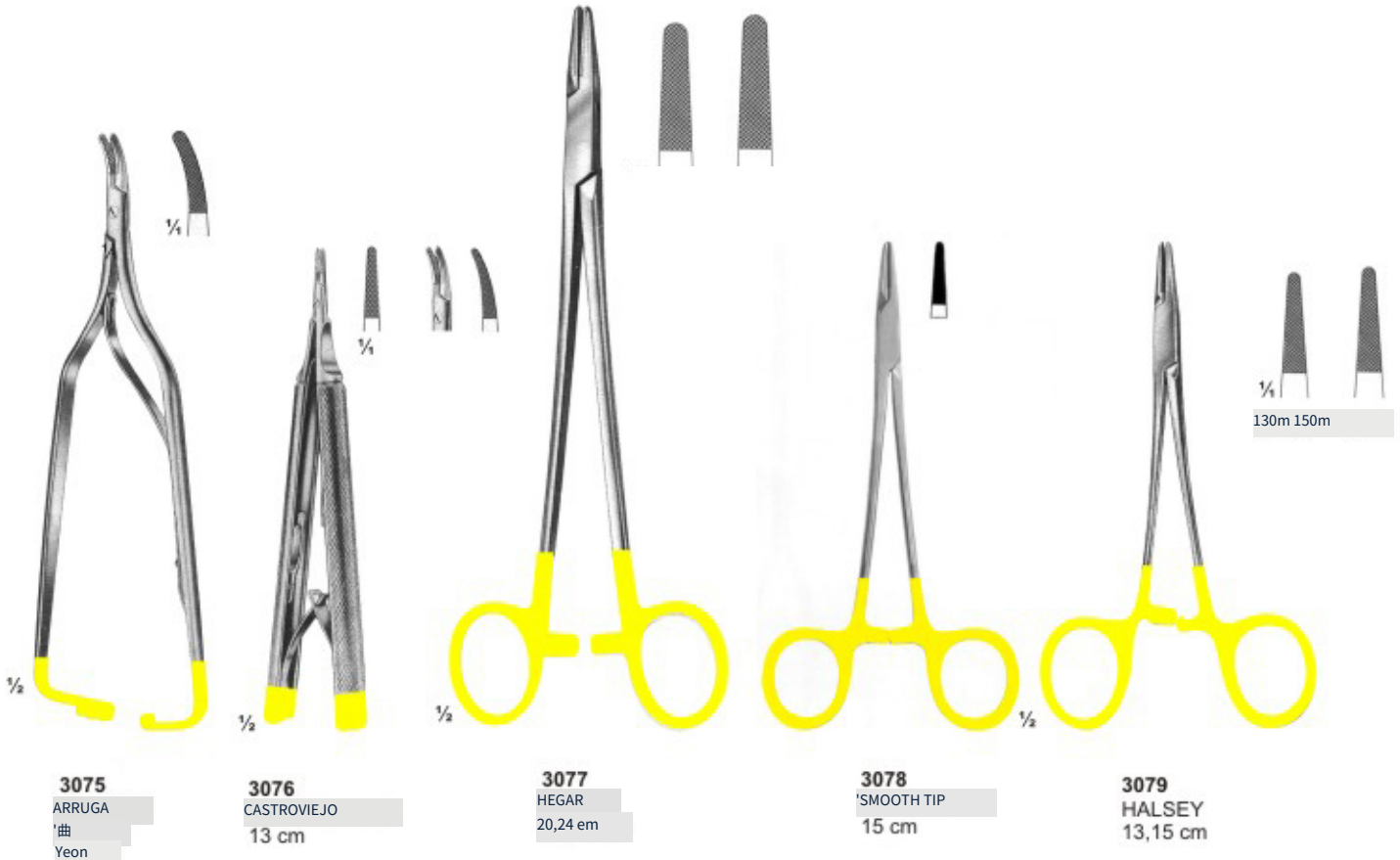

Ad til

ill

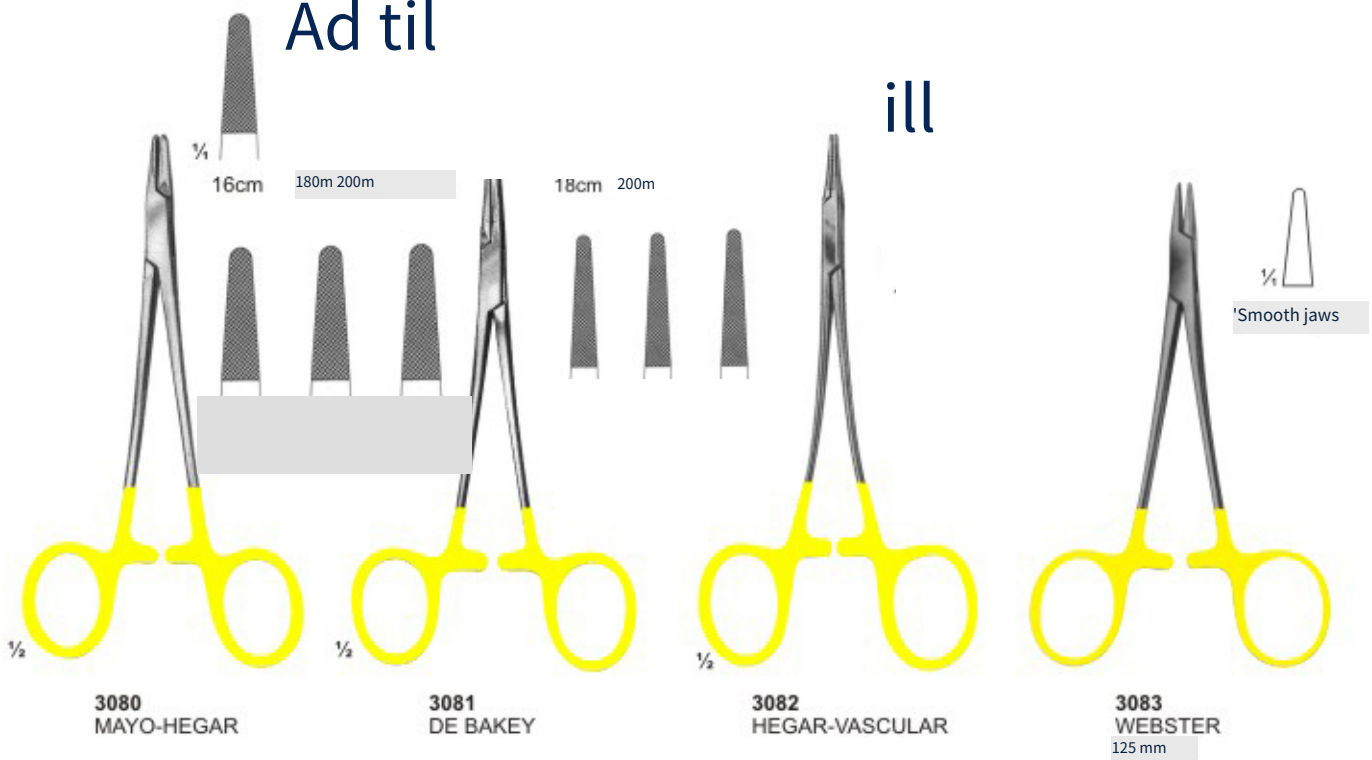

rth

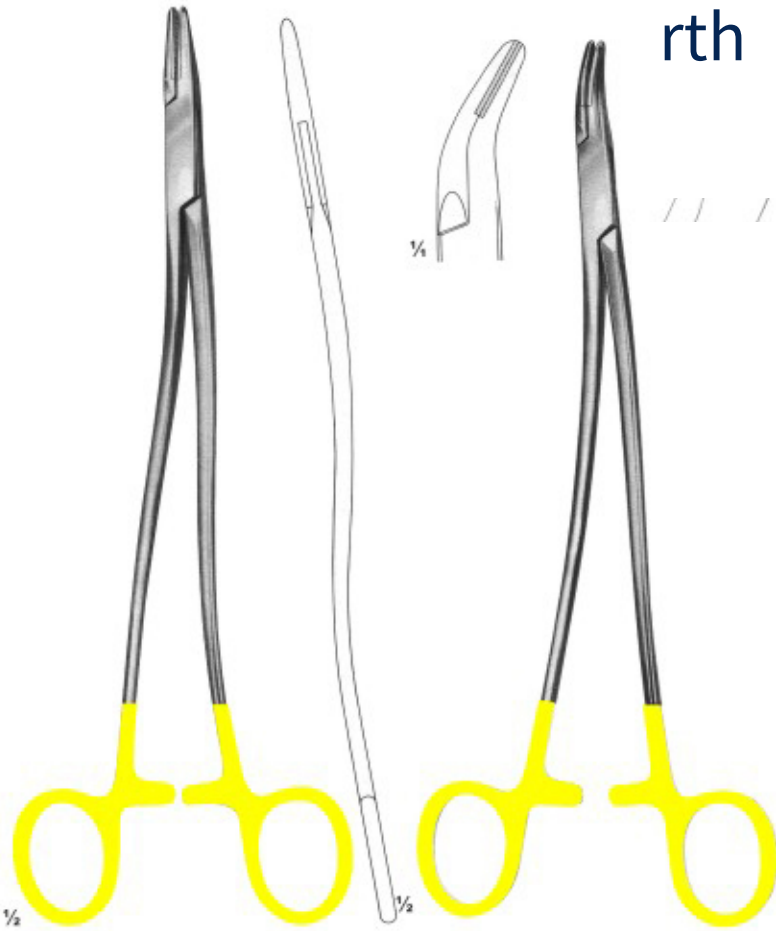

3084
BOZEMANN-WERTHEIM
20, 24, 26 cm

3085
SSTRATE

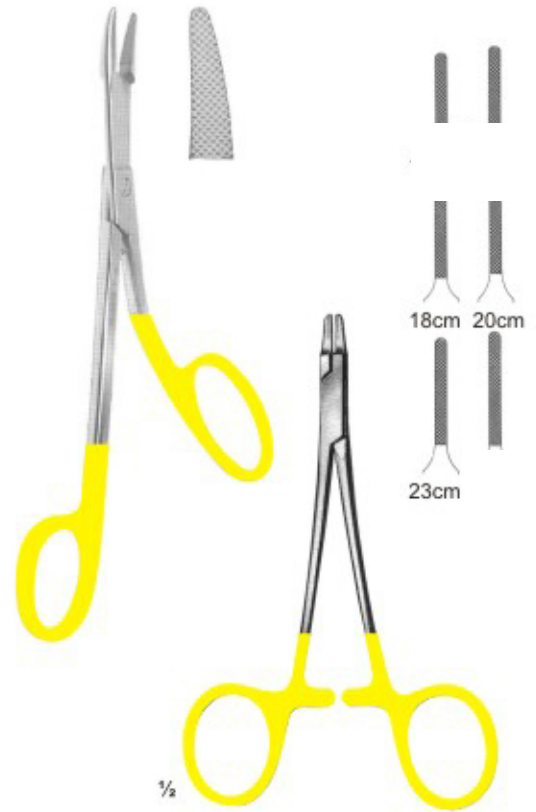

3086
RYDER



3087
RYDER-VASCULAR

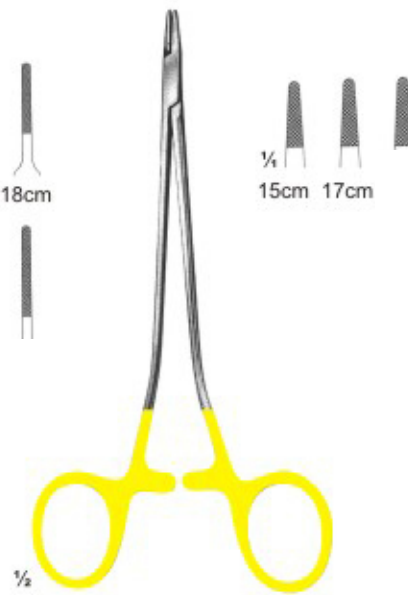

3088
MARTIN

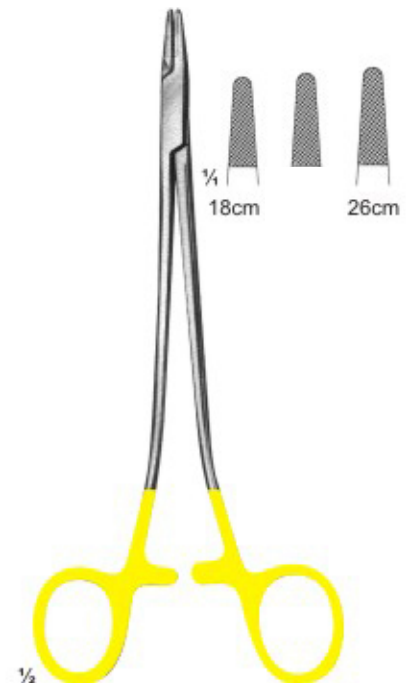

3089
SAROT

iii

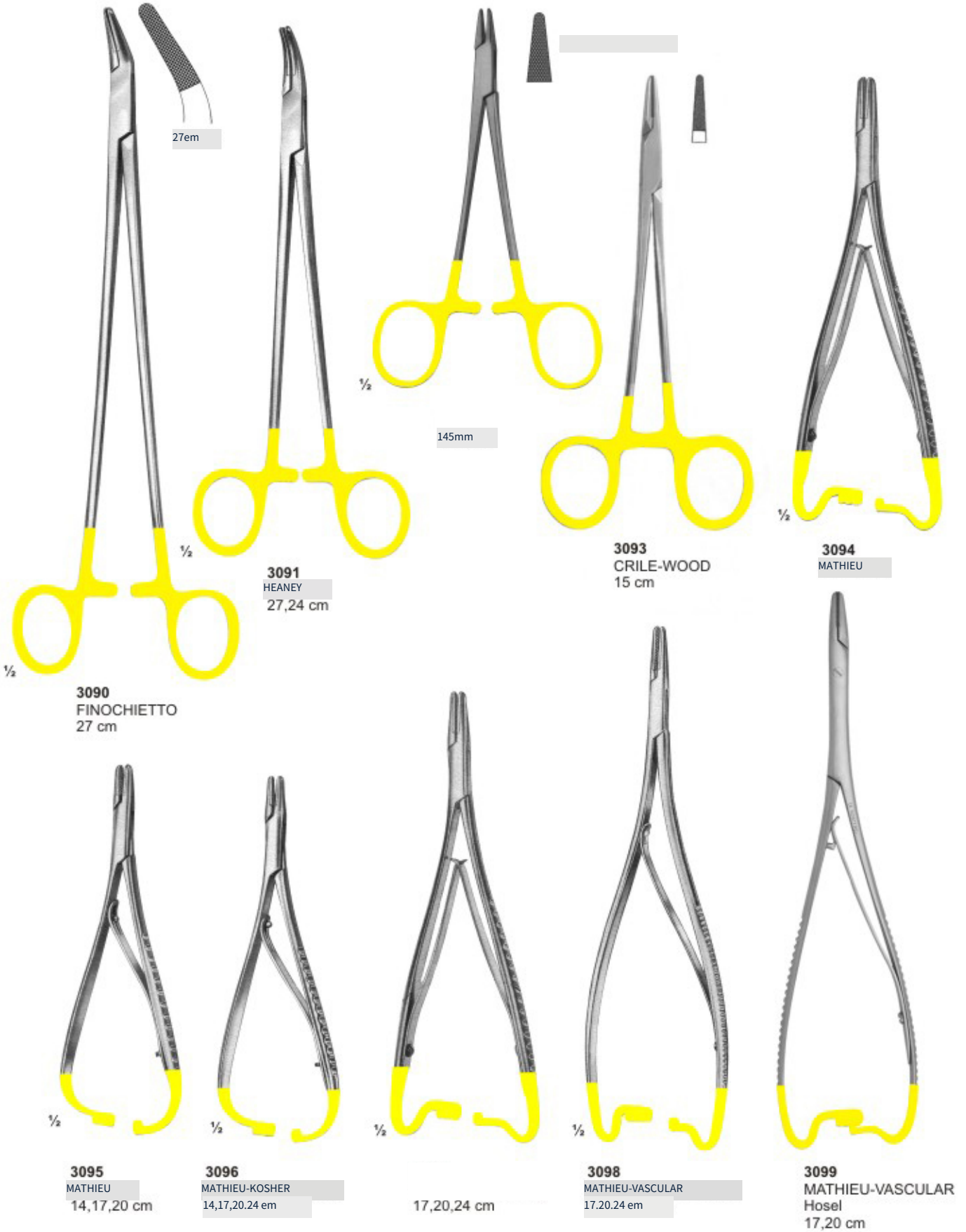



3100
MATHIEU-RYOER
1720,24em

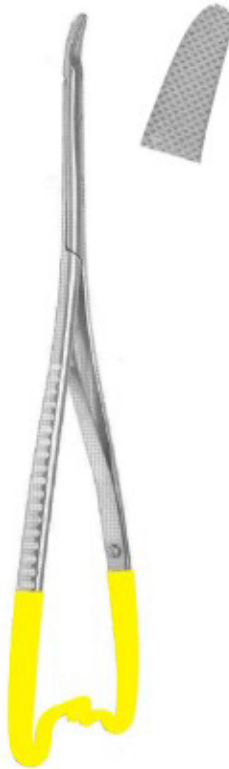

3101
Hosel
曲
200m



3102
LICHTENBERG
20 cm



3103
LANGHALS
20,25 cm



3104
LICHTENBERG
20,25 cm



3105
LUEHTY-BECK
20,25 cm



3106
LUEHTY-BECK
20,25 cm

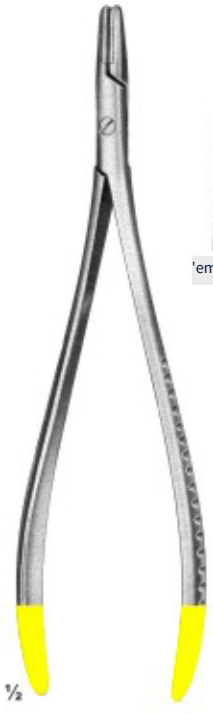

3107

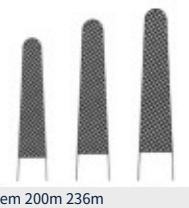

3108
LANGENBECK
18,2023em



Elastic pattern 用
 <dura-または intestinal suture
 180 mm



3110
 Cutting Plier
 12 cm

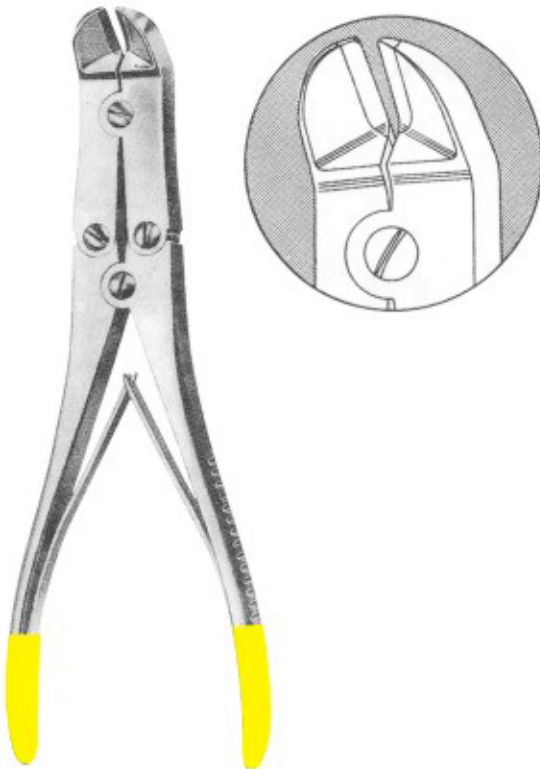

3111
 MULLAR CLAUS
 22 cm



3112
 Plier
 17Sem

K W Alphabetical Index

A

'Adams, Piers	174
...	174
	158,207
'Adson, ピンセット	151
'Ainsworth, ラバーダム Punch	147
Albee	143
Albrecht, ピンセット	155
'Allen, ピンセット	155
Alls, 組織鑷子	158
	97
	97
	97
	145
	145
	175
Andrews, Tongue Depressor	160
	169,174
Apical, 挺子	57,63
'Artuga, T.C. 持針器	208,209
Asticlators	194-195
Aspirating Syringes	149
'Allen 9A, 挺子	50

B

Baby-Allis, 組織鑷子	158
	170
Bane, Rongeurs	179
	110,116
Barry, 挺子	66,69
Baum Gartner, 持針器	180,211
Bee Be, ハサミ	186
Bein, 挺子	54,61
B眼科r, Rongeurs	179
Bird Beak プライヤー	167
Blum耳鼻咽喉科han, Rongeurs	176
Boley Gauge	143
骨キュレット	129
Boynton, 持針器	181
Bozemann-Wertheim, T.C. 持針器	210
	170
Brewer, ラバーダム Instrum耳鼻咽喉科s	147
Brown, 組織鑷子	158
Brown, 組織鑷子	158
	203
	162
Buchs, 開創器	99-100
Burnishers	
Ball Chain	146
Boley Gauge	143

骨 Gauge	144
骨 Mill Forcep	139
骨 プラガー	140
Bracket, Gauge	144
Buser, 挺子	52

C

カーバー	102,103
Castroviejo, 持針器	181,208,209
Castroviejo, ハサミ	186
Castroviejo, Gauge	144
Castroviejo, Sclerer Marker	144
	118,119,121
	120,122
Chisels	103
Chompret, 挺子	63
Cleveland, Rongeurs	177,178
College, ピンセット	152,154
Collier, 持針器	180
Collin, 開創器	162
	110,111,116
'Composite Placement	104,105
'Con Scodellino, Wax ナイフ	126
Cord Packers	95
Cottie, ハサミ	184
Coupland, 挺子	58
'Crane-Kaplan	128
Crile, 鉗子	157
Crile, 持針器	181
Crile-Wood, 持針器	180
	135,136
Crown Removers	134,135
	166
Cryer, 挺子	55,58,69
Cushing, 鉗子	207
	151
Cushing-Taylor, TC. 鉗子	207

D

	207
	184,186,206
	209
	169
Deaver, ハ	184
Denhart,	160
Derf, 持針器	180
Disposable Products	117
Dr.Sader, 挺子	69
ドレッシング鑷子	207
Dean ハサミ	186,205

E	
挺子	51
歯内療法 Condensers	86,87
	126
	89-91
探針	80-82,91-94
抜歯鉗子 (米式パターン)	36-49
抜歯鉗子 (英式パターン)	1-24
抜歯鉗子 (fiting ハンドル)	25-33
抜歯鉗子 (用 小児用)	34

F	
Fahnenstock, Wax ナイフ	126
ヤスリ	125
	106,107
細型, ハサミ	206
Finochietto, T.C. 持針器	ait
Finochietto, T.C. 持針器	211
	175
Flagg, ピンセット	154
Flohr, 挺子	56
Fomon, 組織 開創器	164
Freer, 挺子	52
Friedman, Rongeurs	178
	174
Fim Hanger	146
Finger Cup	197
Flohr, 挺子	57
Freer	15,16,
挺子	52

G	
Gardner, 骨 Chisels	132
Gardner, 持針器	180
Gardner, Rongeurs	178
Gillies, Hook	164
Giles, ピンセット	151
Goldman Fox, T.C. ハサミ	206
Goldman Fox, キュレット	112,113
Goldman Fox 14, 挺子	50
Goldman Fox, ナイフ	114
Gosiee, Pliers	175
Curettes	108,109,116

H	
Halsey, T.C. 持針器	209
ハンドル	72
Hartman, Rongeurs	179

Hatchets	95
Heaney, T.C. 持針器	211
Hegar, C. 持針器	209
Hegar-Vascular, T.C. 持針器	209
Heidbrink, 挺子	64,67,69
Heidbrink, 挺子	57
Howard 9H, 挺子	52
	143
	208
Hlsted-Mosquito, 鉗子	159
	95,125
	196-200
	167,174
	131
Howard, 骨ヤスリ	61
Hylin, 挺子	

I	
Implants Instrum耳鼻咽喉科s	
印象トレー	137-141
Iris ハサミ	187-193
Ivory, ラバーダム Instrum耳鼻咽喉科s	183
	147

J	
	165
Jeseoph, ハサミ	183
	169,175
Joseph, 組織 開創器	164

K	
Kalt, T.C. 持針器	208
Kelly, 鉗子	159
Kelly, ハサミ	183
Kelly ハサミ	205
	165
Kirkland, knife	114
ナイフ	125
Knowles, ハサミ	184
Kocher, 開創器	162
Kocher-Langenbeck, 開創器	162
Kopp, 挺子	60,68
Kopp, ピンセット	151

L	
Lab & Office Pliers	166
Landgraf, ピンセット	154
Langenbeck, Pliers	175
Langenbeck, 開創器	162

Langenbeck, TC. 持針器	212
	110,116
Langhals, T.C. 持針器	212
Leciuse Elevator	65
Lessmann, Wax ナイフ	126
Lexer, TC. ハサミ	202
Lichtenberg, T.C. 持針器	212
Ligature,.C. ハサミ	207
Lip & Cheek 開創器	161,162
Lister, ハサミ	184
Littauer, ハサミ	186
Littler, ハサミ	184
Locklin, ハサミ	186
London 病院, 挺子	62
	154,155
Luehty-Beck, T.C. 持針器	212
Lwanson, Crown Gauge	143
Lagrange, ハサミ	186,205
Littaure, ハサミ	186
Lwanson, Crown Gauge	143
M	
Martin, TC. 持針器	210
Mathieu, 持針器	181,211
Mathieu-Kosher, T.C. 持針器	ant
Mathieu-Ryder, T.C. 持針器	212
Mathieu-Vesicular, T.C. 持針器	211
Mayo Harrington, ハサミ	205
Mayo, ハサミ	185,204
Mayo-Hegar, 持針器	181
Mayo-Hegar,.C. 持針器	209
	202
	202
Mayo-Stile ハサミ	185
	175
	110,111,116
Meindorff, ピンセット	151
	133
Mead, 挺子	64
	179
	207
Meriam, ピンセット	153,155
Metzenbaum Fino, T.C. ハサミ	203,204
	185,203
	182
Micro-Adson, ピンセット	151
Micro-Friedman, Rongeurs	178
Middledorpf 開創器	162
Miller, Articulating 鉗子	147
Miller, 骨ヤスリ	130

Mini-Blum耳鼻咽喉科han, Rongeurs	176
Molt, 挺子	50
Mott, 口腔 開口器	160
Molt 9, 挺子	50
Morrison, 挺子	56
歯鏡付き ハンドル	73
MSY, Piers	175
Mullar Claus, Wire Cutting プライヤー T.C	213

N

Nar ice,	168,169,174
Napkin ホルダー	146
Neivert, 持針器	180
Nelson-Metzenbaum, ハサミ	185
Non Chill	146

O

	168
Obturation Instrum耳鼻咽喉科s	88
Ochsenbein	128
Ordan, knife	114
Oehier, 鉗子	208
Olsen-Hegar, 持針器	180
Optical Pliers	168
矯正 Cutters, TC	172
矯正 Distal & Cutters	173
矯正 Piers, T.C	171
Ott, 挺子	62

P

Parametrium, T.C. ハサミ	205
Partsch, 骨 Chisels	133
Partsch, 骨 Mallet	133
Pean, 鉗子	157
	166,175
Peets, 鉗子	157
Perry, ピンセット	151
PK. Thomas	96
Pich	98
プラグー	98
Prichard, 挺子	50
Plastic ハンドル 挺子	70
Polokoff, 骨 ヤスリ	131
	51
	208
Potts-Smith, T.C. 持針器	208
プローブ	82-85,91,94

Q

Quinby, ハサミ	183
-------------	-----

Ce Alphabetical Index

R

Ragnell, C. ハサミ	206
リテーナー, Bands	146
Reynolds, Phers	169,174
	115
	35
Roux, 開創器	162
ラバーダム Clamps	148
ラバーダムホルダー	147
Rule, Curette	110
Russian, 組織鑷子	158
Ryder, T.C. 持針器	210
Ryder-Vescula, T.C. 持針器	210

S

Sarot, TC. 持針器	210
	75-79
メスハンドル	71
	168,175
	114
Seldin, 挺子	50,55,67
Select, ピンセット	151
'Semken, 鉗子	207
Semkin, 組織鑷子	158
Senn, 組織開創器	164
	166
	205
	123
Spencer, ハサミ	186
Spencer-Wells, 鉗子	157
Spreaders	87
Split Chisels	128
Spring Bow Divider	143
	201
標準, ピンセット	151
	166
滅菌 & Lab Instrum耳鼻咽喉科s	156
Sterilizing 鉗子	163
Stevens, 持針器	181
Stevens, ハサミ	183
Stile, ハサミ	185
Stratte, T.C. 持針器	210
	146
Syringes	150
'吸引管	140,142
Sugarman, Fle	114

T

Toennis, Wire Cutting プライヤー T.C	213
---------------------------------	-----

Toennis-Adson, ハサミ	184
Toennis, 組織開創器	164
'Towel Clamps, Napkinホルダー	159
	168
Telescope, Crown プライヤー	136
Traymann, Crown Remover	128

U

Universal, TC. ハサミ	207
	174
Universal, 挺子	135
Utility Pier	165

V

Vernier, Measuring Instrum耳鼻咽喉科s	143
Vernier Gauge	143

W

Wakefield, 骨 Chisels	132
	174
	174
Wangensteen, TC. 鉗子	208
Warwick-James, 挺子	62
	151
Wax & Modeling カーバー	120
Wax & Plaster ナイフ	127
Wax カーバー	101
Wax, Porcelain Instrum耳鼻咽喉科s	118,119,121
	180,209
	167
Weitlaner, 開創器	160
West, 挺子	50
White, ラバーダム Instrum耳鼻咽喉科	147
Wieder, Tongue Depressor	160
Winter, 挺子	65,69
Wire & Clasp Bending プライヤー	170
Wire Bending Piers	166
West, 挺子	50
Wire Cutter	165
'Woodson	98

Y

Young, Piers	168,174
--------------	---------

Z

Zuricher, Measuring Instrum耳鼻咽喉科	143
Zuricher, Gauge	143



 **NMASOOD
SURGICALS**
HEALTH EQUITY ALWAYS



[Redacted address]



090-1322-4562

FOLLOW US

