

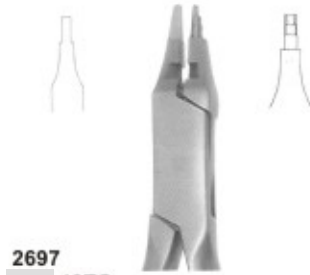

2696
38c 38TC
13.5 cm, 5 1/4"
Contouring closing loop プライヤー
wire bending, cutter



2697
40c 40TC

'grooved 付き cutter

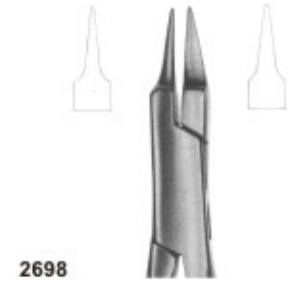

2698
図 81
12.5 cm, 5"
Sling clasp & wire bending プライヤー



2699
図 28
14 cm, 5 1/2"
'Sling & wire bending プライヤー



2700
図 21
13.0m, 5 11 }"
Light wires プライヤー, grooved



2701
'ADAMS, 23, 23TC
12.5 cm, 5"
Sling clasp & wire bending pier



2703
'ADAMS (図 44)
12.5 cm, 5"
Sling clasp & wire bending pier



用 retaining elem耳鼻咽喉科



2705
Universal Wire Bend
Piers (ADAMS) 47 TC, N64
425cm, 5"
Sling clasp & wire bending pier



1254m, 8°
Sling clasp & wire bending プライヤー

2704
46c - 46 TC
'ADAMS -N. 139c
12.5 cm, 5"
Bird beak 付き cutter

— K W 矯正 Cutters 付き

.C.



∅ 1.0 mm
(0.40")

2707
 ☒ 1870
 15 cm, 6"



∅ 1.0 mm
(0.40")

2708
 ☒ 827
 14 cm, 5 1/2"



04mm
(0.16")



004mm
(0.16")

2710
 ☒ 99 TC
 13cm, 5 1/8"



0.4mm
(0.16")

2711
 ☒ 94 TC

ハンドル

was



Angled at 15
 13 cm, 5 1/8"

85 TC
 13 cm, 5 1/8"

87 TC
 13cm, 5 1/8"

13.0m, 5 1/8"

— W 矯正 Distal & Cutters





2721
UNIVERSAL
150 mm

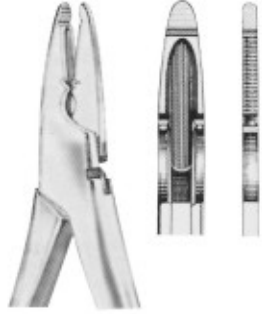

2722
WALDSACHS
155 mm



2723
ADERER
125 mm



2724
NANCE
125 mm



2726
HOW
145 mm



2727
HOW
140 mm



2728
WALDRON
125 mm



2729
ADAMS
125 mm



2730
ANGLE
125 mm



2731

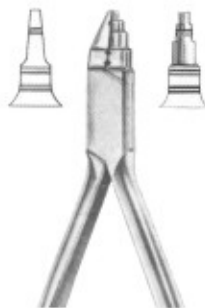

2732
YouNc
130 mm



2733
NANCE
130mm



2734
LANGEBECK
125 mm



2735
LANGEBECK
140mm



2736
LANGEBECK
130 mm

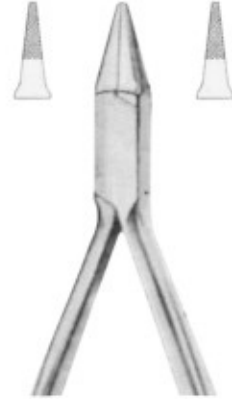

2737
PEESO
125mm



2738
GOSLEE
125 mm

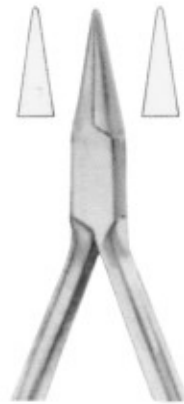

2739
FISCHER
140mm

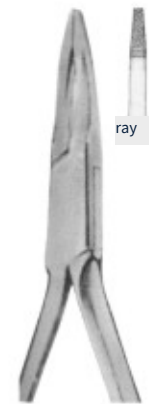

ray



2741
JOHNSON
130 mm

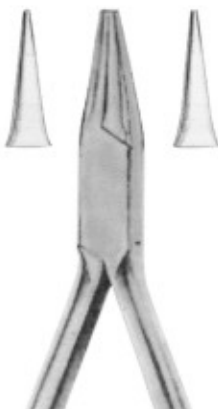

2742



2743
MC KELLOPS
155mm



2744

EN



274s
SCHWARZ
130mm



2746
BLUM耳鼻咽喉科HAL
6", 308 Standar d

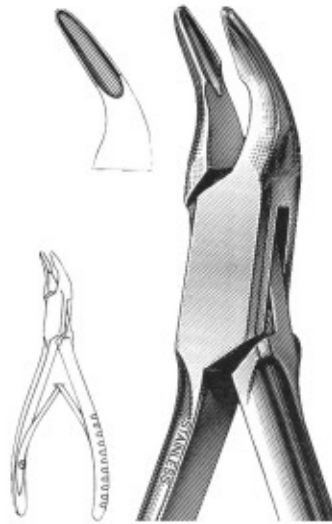

2747
MINL-BLUM耳鼻咽喉科HAL
6", 45°

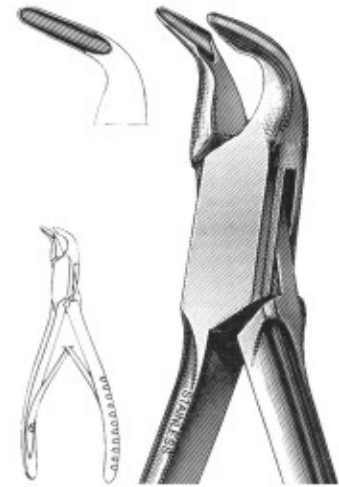

2748
MINK BLUM耳鼻咽喉科HAL
6", 90°

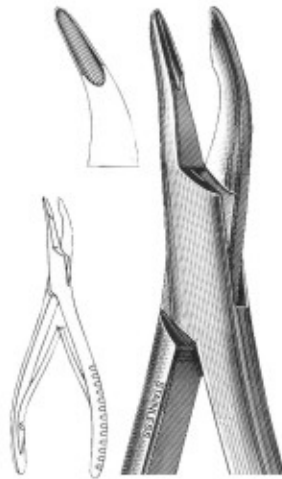

2749
BLUM耳鼻咽喉科HAL
7", 30°

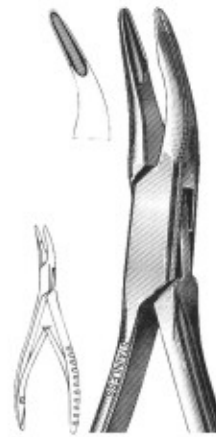

2750
MINI-BLUMENTHAL
4 1/2", 30°

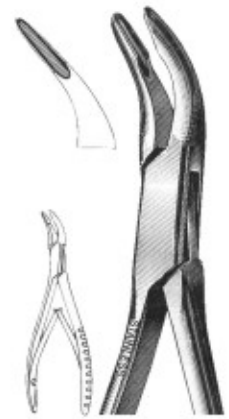

2751
MINI-BLUMENTHAL
4 1/2", 45°

— W Rongeurs



2752
CLEVELAND
No. 8-Side Cutting
6 3/4"

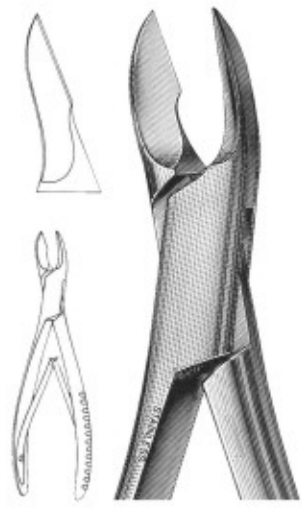

2753
CLEVELAND
No. 5A-Side Cutting
6 1/2"

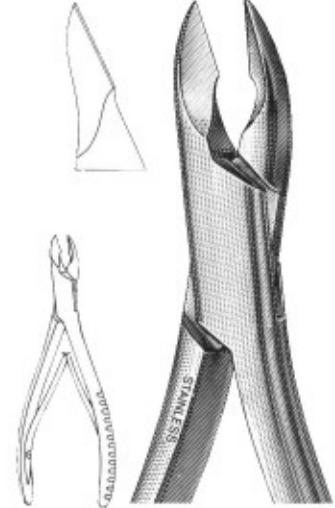

2754
CLEVELAND
No. 5-Side Cutting
6"

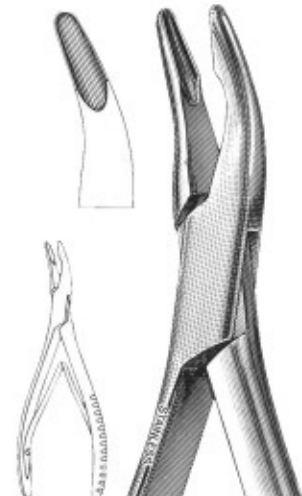

2755
No. 1A-MEAD
6 1/2"

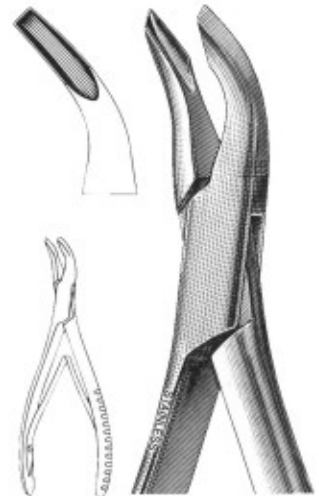

2756
MEAD, Square
No. 2A
Tips. 6%



2757



2757
 FRIEDMAN
 5 1/2"

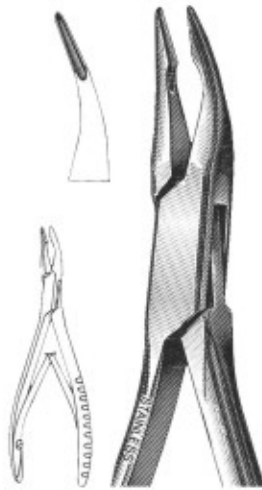

2758
 MICRO-FRIEDMAN
 5 1/2", 15° C

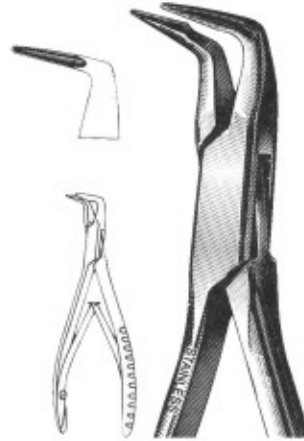

2759
 MI
 F 5 1/2"

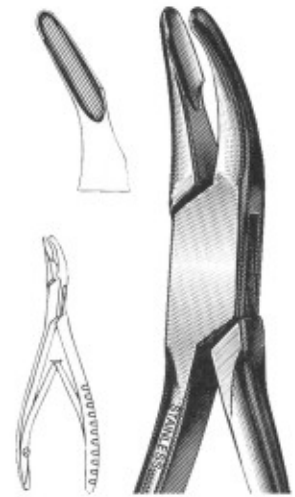

2760
 CLEVELAND
 No. 4 - 5 1/2"

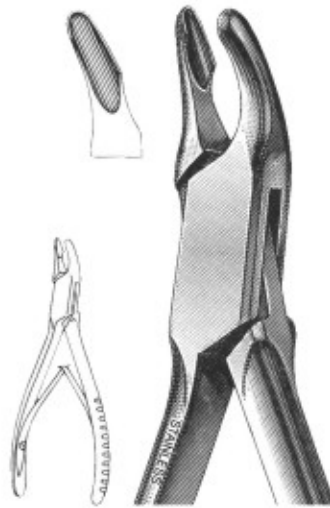

2761
 CLEVELAND
 No. 4A - 6 1/2"

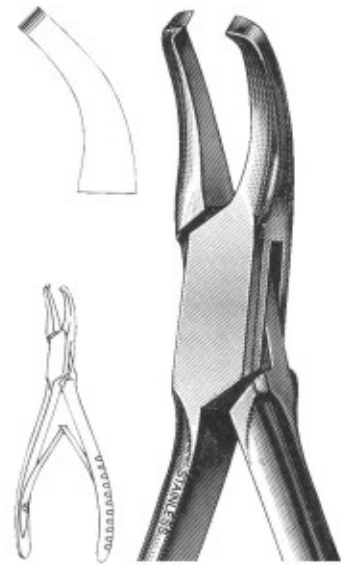



2763
眼科R
tion,



2764
6 1/2"

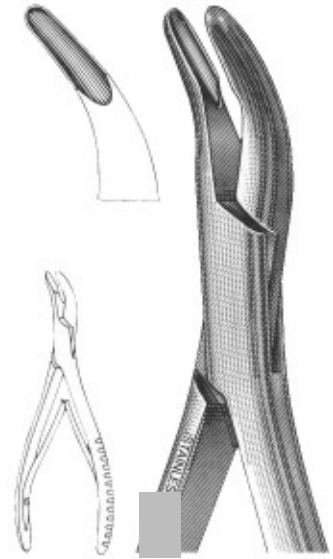

2765
HARTMAN

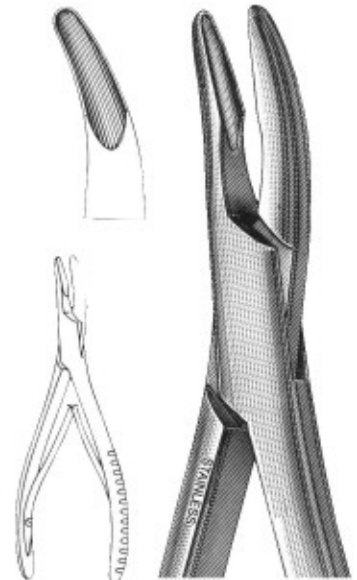

2766



2767
OLSEN-HEGAR
5", F



2768
DERF
4 3/4"



2769



2770
NE
On
5"

ity



2771
OLSEN-HEGAR
5 1/2"



2772
BAUMGARTNEF
5 1/2"



2773
CRILEWOOD
6"



2774
GARDNER
5"



2775
MAYO-HEG
5"



2776
ROVIEJO
Smooth Jaws
4 cm

2777
CASTRO
Smooth
14 cr



2778



2778
CASTROVIEJO
Smooth Jaws
14 cm



2779 A
18 cm



2780 A
18 cm



2781
BOYNTON
5"



2782
CRILE
6"



2783
MATHIEU
5 1/2"



2784
STEVELMANS
6 1/2"



2785
Micro Scissor
Straight,



2786
Micro Scissor
Straight, 150 mm



2787



2788



2789
CASTROVIEJO
T.C.
Straight, 180 mm



2790
Retractor
Fig.3
165mm



20mm



2792
GERALD
Curve
180 mm



2793
GERALD
Straight,
175mm

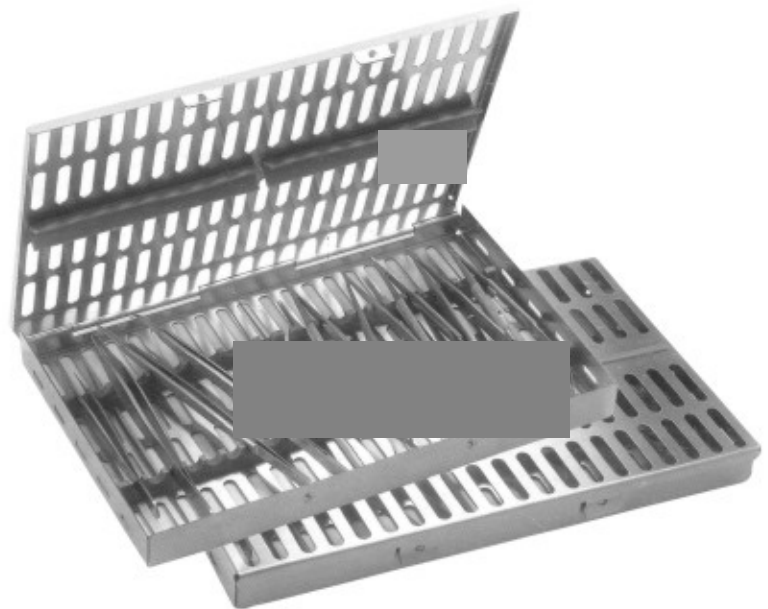

W ハサミ

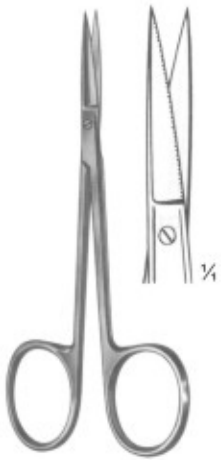

Straight
11.5 cm, 4 1/2"

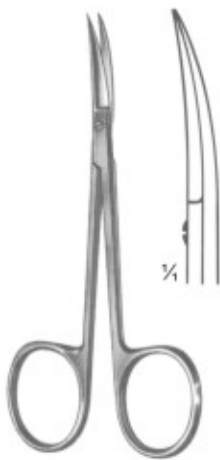

Curved
11.5 cm, 4 1/2"



2798
STEVENS
Dissecting ハサミ
Size: 115mm

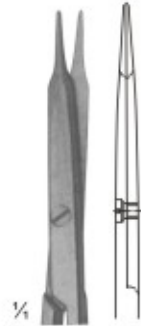

2799
Sharp



2800
'Sharp



2801
Blunt

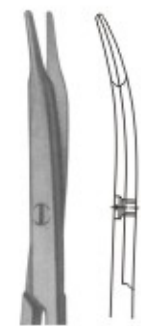

2802
Blunt



2803

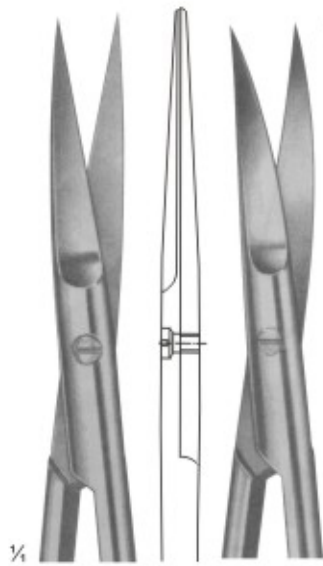

2805

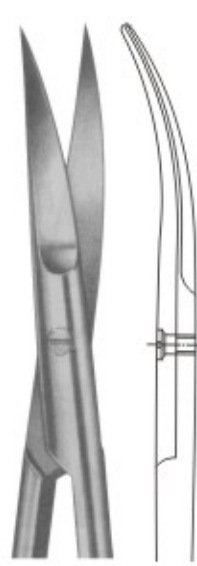

2806

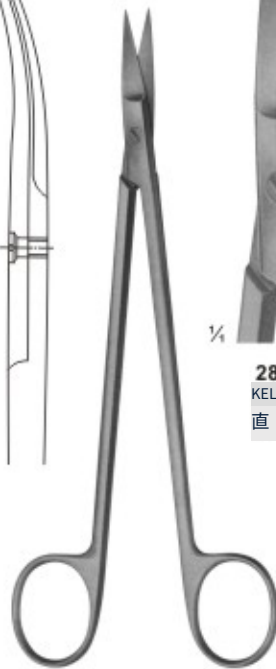

2808
KELLY
直

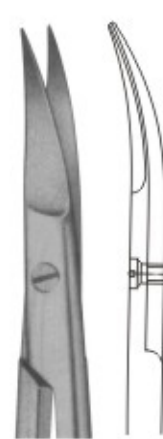

2809
KELLY
曲

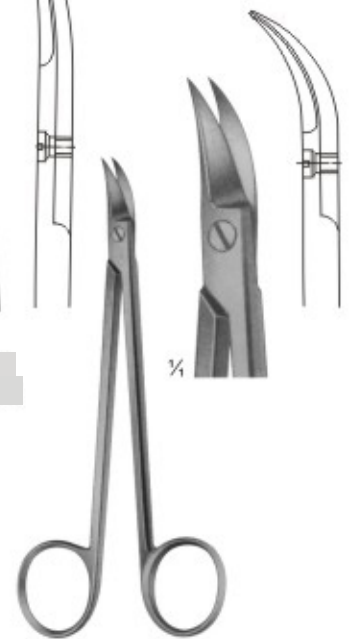

2810

2807
KELLY
サイズ: 175mm

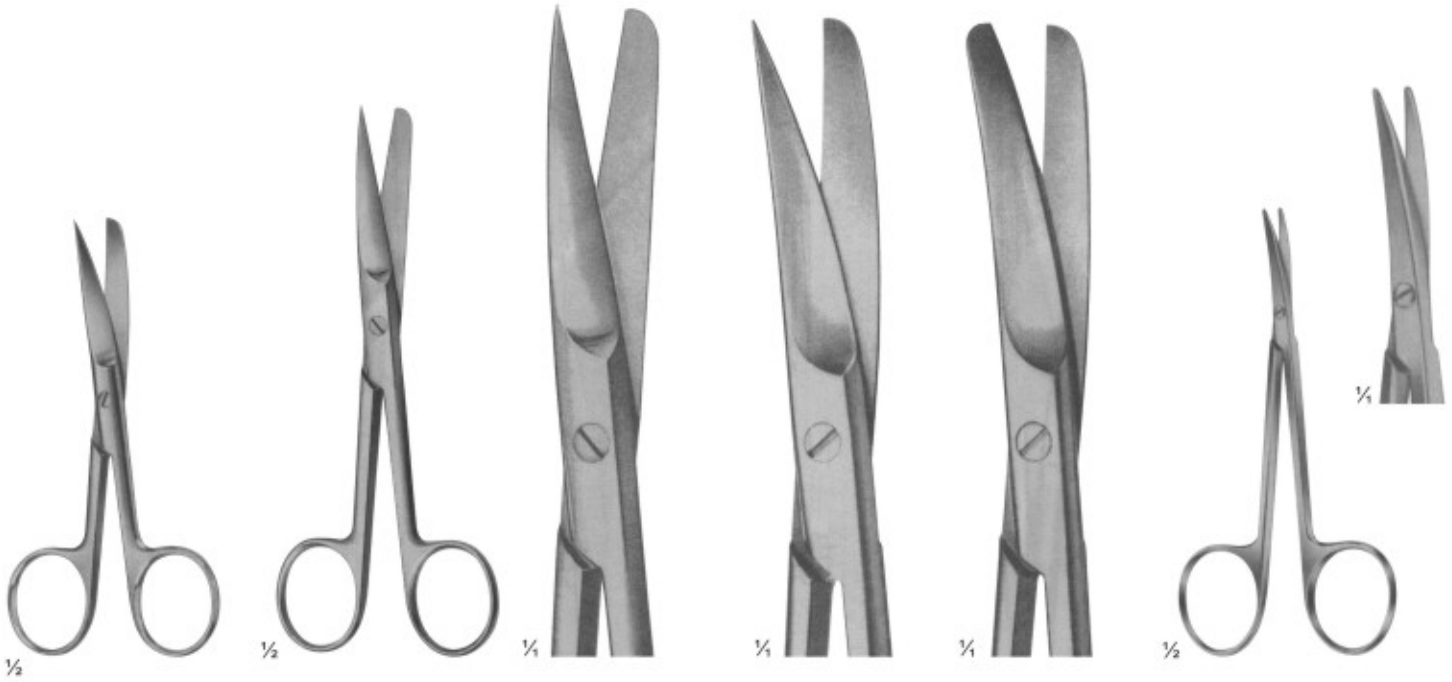

2811
標準 - Types
サイズ: 115mm

2812

2814
サイズ: 145mm

2815
サイズ: 145 mm

2816
LITTLER
Dissecting ハサミ
サイズ: 115mm

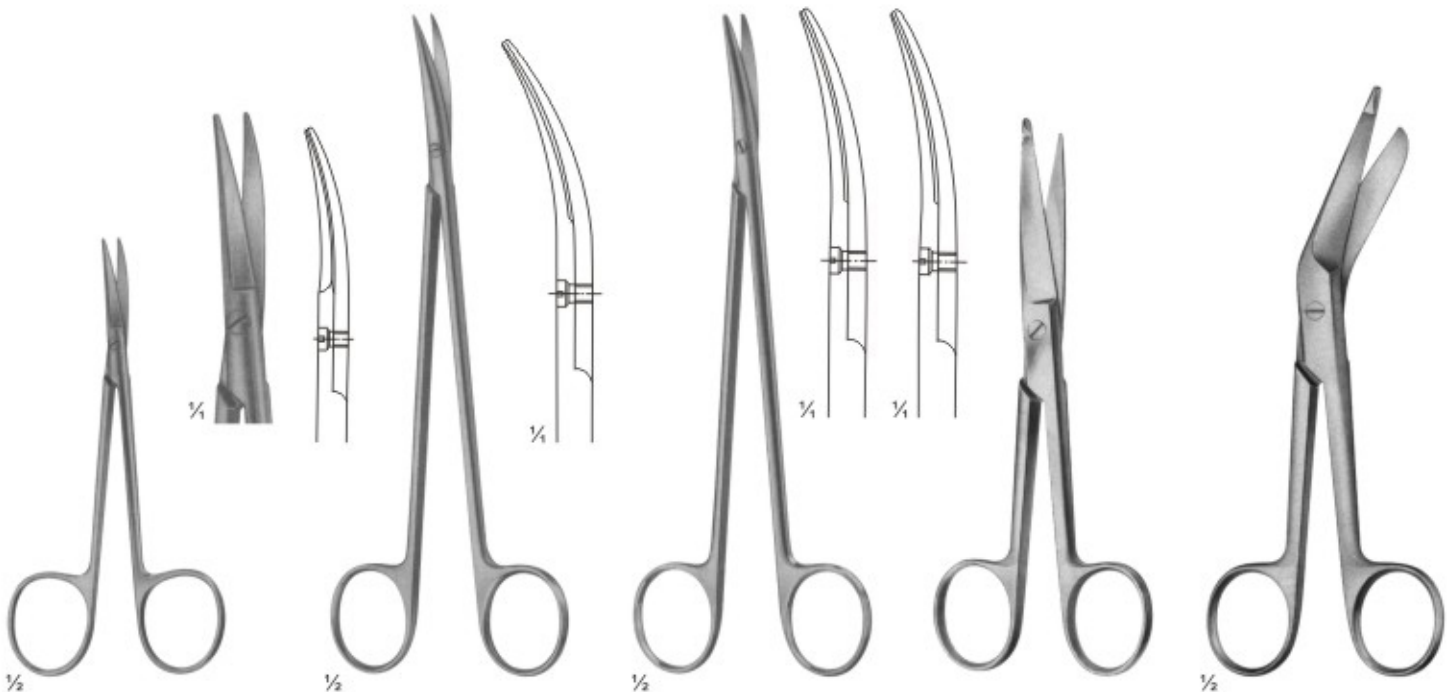

2817
come
'Bulldog ハサミ

2818
DE BAKEY
'Ateriotomy ハサミ
サイズ: 175mm

2819
175mm

2820

2821
LUSTER



Scissors

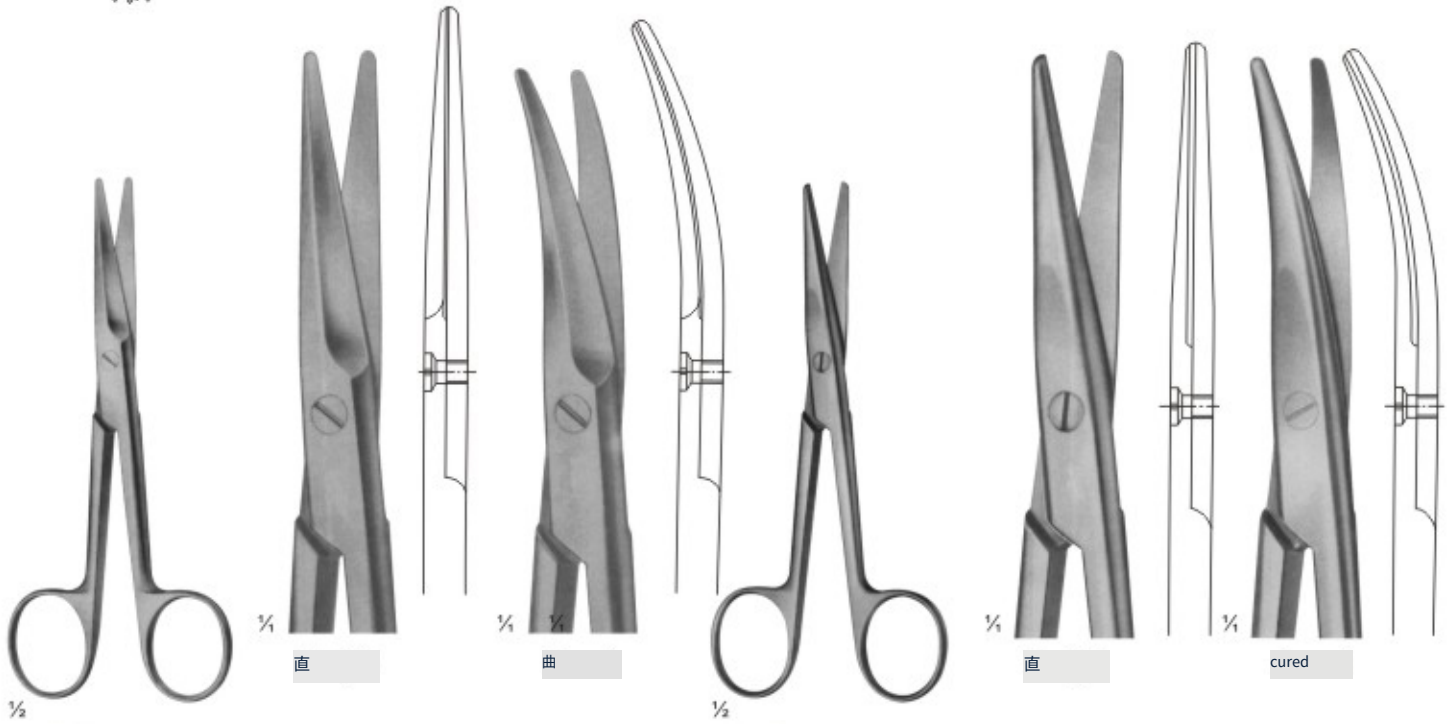

2822
MAYO(straight)
サイズ: 140 mm

2823
MAYO-
サイズ 14



2825
METZENBAUM
サイズ. 145 mm

2826
NELSON-METZENBAUM
Size: 230 mm

KW ハサミ

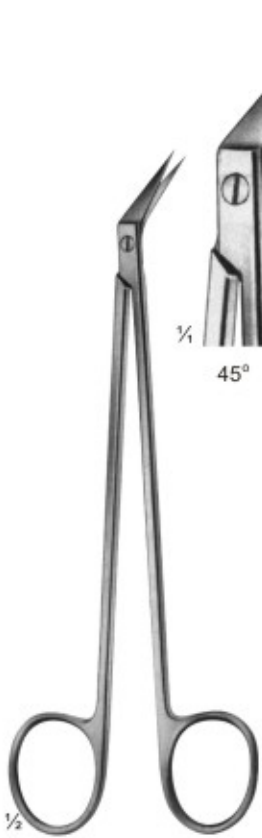

2827
DE BAKEY
Size: 155 mm



45°
60°

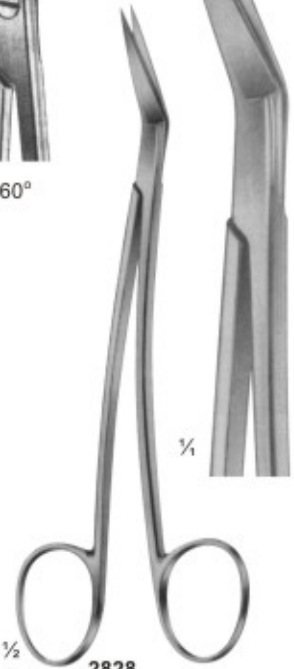

2828
LOCKLIN
Cured Sideways
blade
1m



2829
Double-Curved
13cm



2832
LITTAUER
R
mm

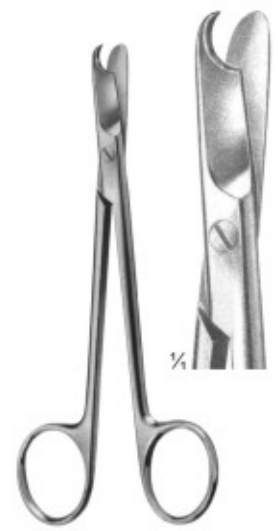

2832
LITTAUER
Size: 135 mm

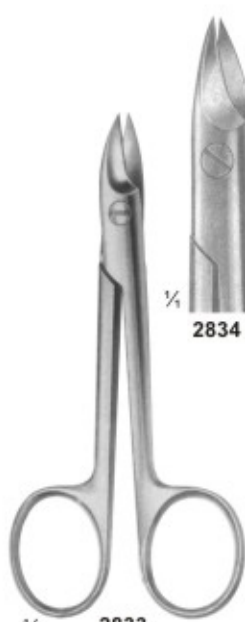

2833
BEEBE
Size: 110 mm

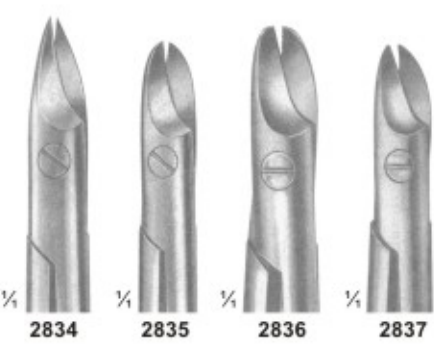

2834 **2835** **2836** **2837**

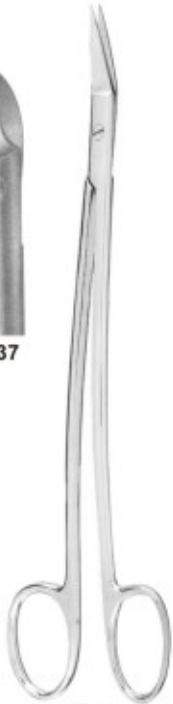

2838
Dean
17cm



2838

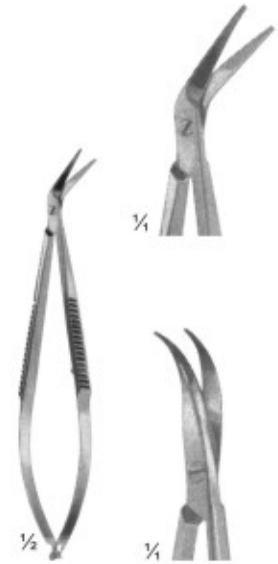

2840

mm

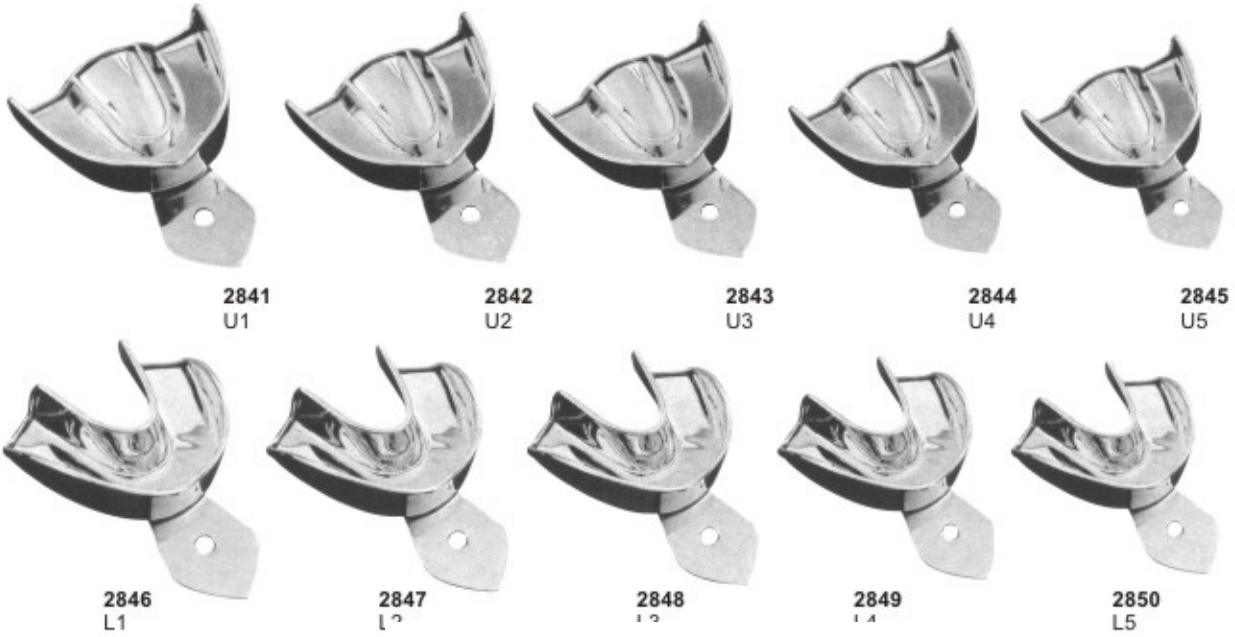

All Thickness

UPPER		U1					U2						
		A	62	60	53	54	52	A	63	61	57	56	
B		83	75	73	69	68	LOW		L5				
							B	82	81	78	74	71	

All Dimension are in mm

All Dimension 1 mm

Perforated, Set ϕ 10

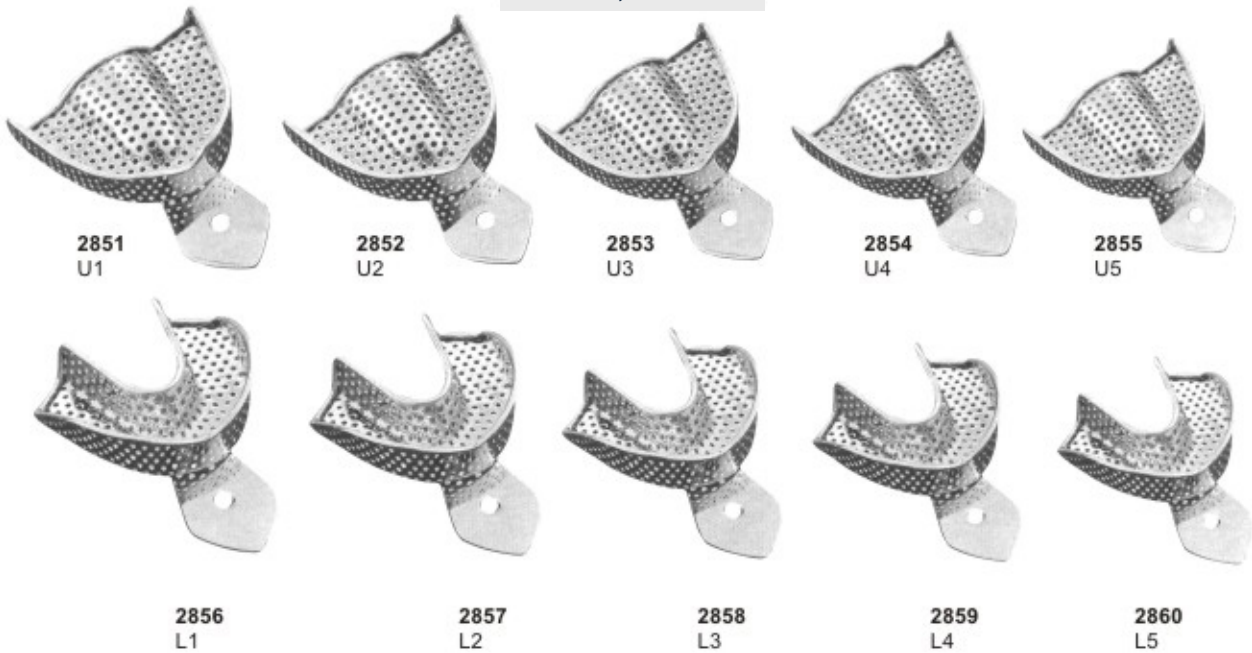



2861
XL



2862
L



2863
M



2864
S



2865
XL



2866
L



2867
M



2868
S

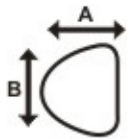

UPPER	XL	L	M	S
	A	70	67	64
B	79	76	70	70

All Dimension

WEIGHT	M	S
	A	64
B	70	73

All Dimension are la mam



2869
XL



2871
M



2872
S

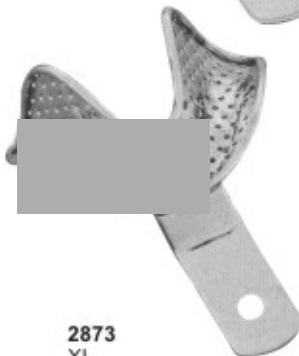

2873
XL



2874
L



2875
M



2876
S



2877
U1



2878
U2



2879
U3



2880
L1



2881
L2

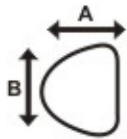

UPPER	U1	U2	U3
	A	67	64
B	81	74	70

LOWER	L1	L2	L3
	A	60	57
B	81	79	76

All Dimension



2883
U1



2884
U2



2885
U3



2886
L1



2887
L2



2888
L3



2889
下顎



2890
上顎

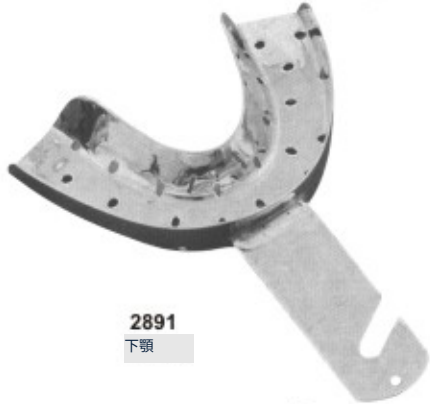

2891
下顎



2892
上顎



2893
下顎



2894
上顎

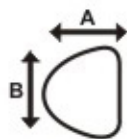

UPPER	Size	A	B	C
	0	67	50	12
	1	72	51	13
	2	78	55	15
	3	80	58	15

LOWER	サイズ	A	B	C
	0	70	50	14
	1	77	51	15
	2	79	55	15
	3	80	60	17

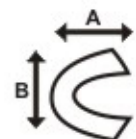

All Dimension

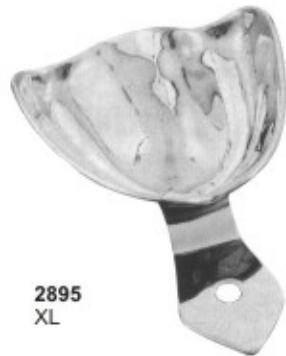

2895
XL

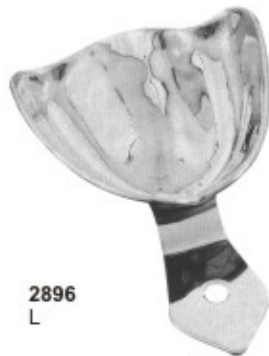

2896
L

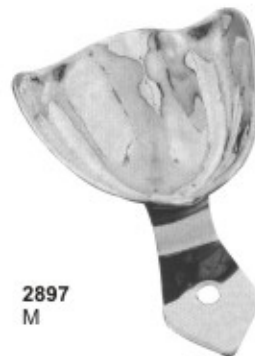

2897
M



2898
S



2899
XL



2900
L



2901
M



2902
S

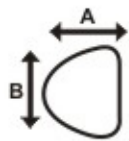

UPPER		XL	L	M	S
A		67	64	60	
B	79	76	70	72	

All Dimension

LOWER		XL	L	M	S
A		64	60	57	
B	86	70	73	72	

All Dimension



2903
XL



2904
L



2905
M

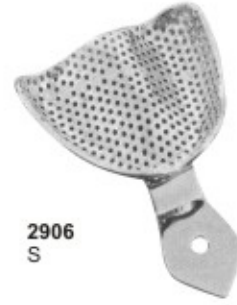

2906
S

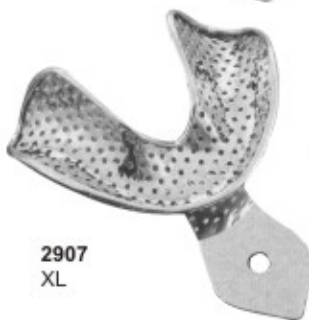

2907
XL

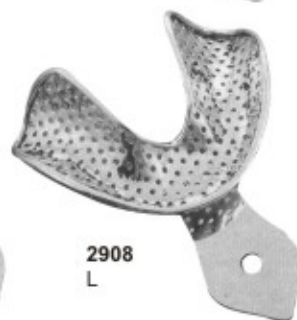

2908
L

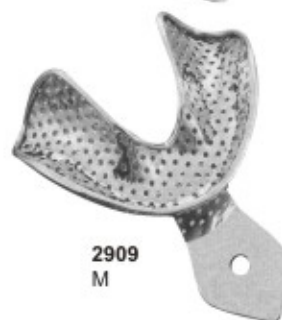

2909
M

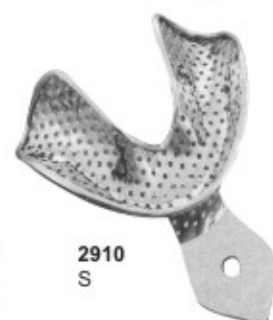

2910
S



2911
U0



2912
U1



2913
U2



2914
U3



2915
L0



2916
L1



2917
L2



2918
L3

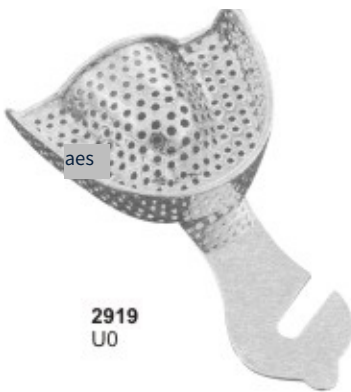

2919
U0

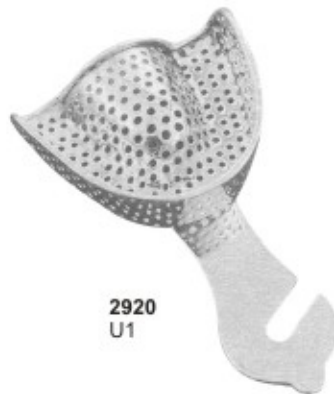

2920
U1

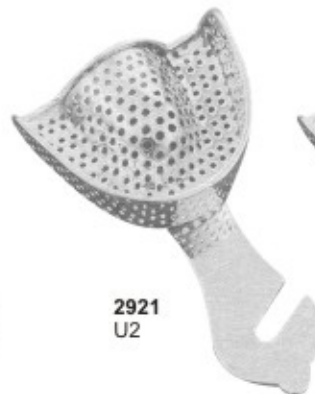

2921
U2

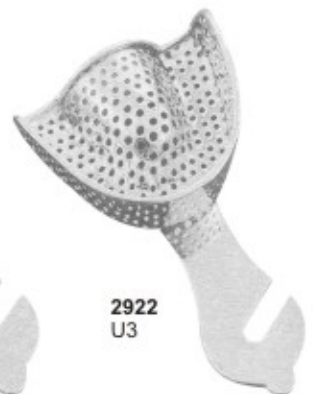

2922
U3



2923
L0

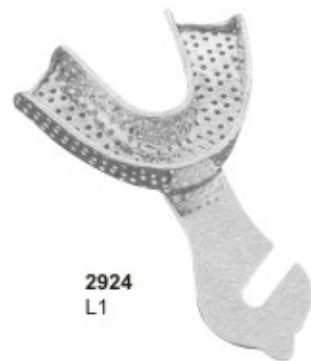

2924
L1

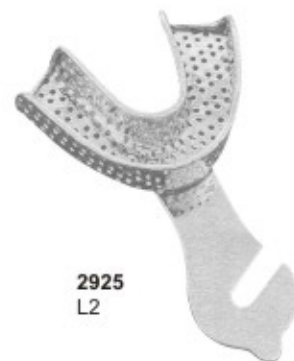

2925
L2

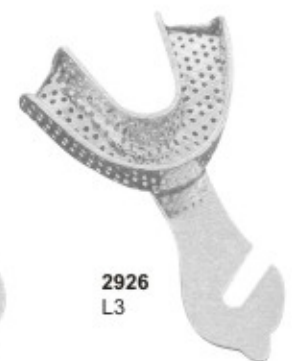

2926
L3



2927
U1P



2928
L1P



2929
U1P



2930
L1P

SOLID

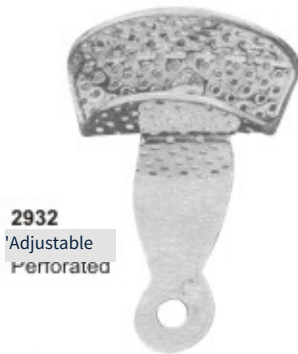

2932
Adjustable
Perforated



2933
Adjustable
Solid

PERFORATED



2931-A
For upper right jaw
For lower left jaw

2931-B
upper left jaw
lower right jaw

SOLID



sizes	
1.....	mm
2.....	55 mm
3.....	
4.....	

Available 4 サイズs	
1.....	
2.....	
3.....	
4.....	65 mm



SES



2934

2935



2936



2937

PES &



2939



2938



2940



2941



2942



2943



2944



2945



2946



2947